

**Ministry of Education and Science of Ukraine  
Donbas State Machine-Building Academy (DSEA)**

**S.V. Kovalevskyy, O.S. Kovalevska**

**MAGNETIC RESONANCE  
MATERIAL PROCESSING**

**Monograph**

Approved  
at a meeting of the Academic Council  
Protocol № 4 dated 5.11.2020

Kramatorsk  
DSEA  
2020

UDK 621:004.9

M 44

**Authors:**

*Kovalevskyy S.V.*, Dr. Tech. Sciences, Professor, Head of the Department Of Technology mechanical engineering of the Donbas state Machine - building academy;

*Kovalevska O.S.*, Candidate of Technical Sciences, Associate Professor of the Department Computerized Design and Modeling of Processes and Machines;

**Reviewers:**

Andilahai O.O., Dr. Tech. Sciences, Professor, Priazovsky State technical University;

Kianovsky M.V., Dr. Tech. Sciences, Professor, Kryvyi Rih National University;

**Recommended**

Academic Council of the Donbas State Engineering Academy

M 44 Magnetic resonance processing of materials: monograph / S.V.Kovalevskyy, O. S. Kovalevska. – Kramatorsk : DSEA, 2020. – 111 p.  
ISBN

The monograph provides the basics of magnetic resonance processing of materials, which are formed on the basis of generalization of own theoretical and experimental studies of the influence of stationary and moving magnetic field on the properties of structural steels and on the material of non-grinding cutting plates. It is proved that vibration processing at natural resonant frequencies has prospects for further use. Recommendations for the use of neural network analysis methods for the diagnosis of the proposed treatment with subsequent management.

It can be used by specialists, graduate students and students of mechanical engineering and technological specialties.

**UDK 621:004.9**

ISBN

© С. В. Ковалевський,  
О. С. Ковалевська, 2020  
© ДДМА, 2020

# CONTENT

	P.
FOREWORD.....	4
SECTION 1. PHILOSOPHICAL BASIS OF THE UNIVERSE: MATTER, ENERGY, INFORMATION.....	5
SECTION 2. OBJECT PROPERTIES AS A REFLECTION INTERACTIONS OF SUBSTANCE AND FIELD.....	13
SECTION 3. CHANGE OF PROPERTIES OF SUBSTANCES AS A CONSEQUENCE OF A CHANGE IN THE INTERACTION OF SUBSTANCE AND FIELD.....	19
SECTION 4. MAGNETIC FIELD AND ITS PROPERTIES.....	22
SECTION 5. FEATURES OF VIBRATION PROCESSING MATERIALS.....	26
SECTION 6. MAGNETIC RESONANCE TREATMENT MATERIALS.....	57
SECTION 7. MAGNETIC RESONANCE ACTIVATION STRENGTHENING TREATMENT.....	74
SECTION 8. RECOMMENDATIONS FOR THE USE OF NEURAL NETWORK ANALYSIS METHODS FOR OBJECT DIAGNOSIS.....	103
REFERENCES.....	114

## PREFACE

In modern conditions, it is important to have an idea of the features of production systems that would meet the requirements of technological and structural flexibility with extremely limited material and energy resources. This idea is especially relevant for the further evolution of machine-building production.

Previous research has shown that reconfigurable systems differ from existing systems in their ability to change. The main advantage is the ability to have exactly the right flexibility for the products. The fact that with its ability to flexibility, RVS is much more economical than existing flexible systems is also very beneficial for manufacturers. This is due to the use of more convenient equipment. Flexible systems and machines are created with all possible functionalities, because the scope of use of the processing center is uncertain, which creates the main costs, thus providing the general assumption that DHW is able to produce any product (within a given family), in any combination, details and in any sequence. This approach increases the likelihood of increasing the cost of machined parts because it requires a parallel system structure for DHW that uses powerful general-purpose machining centers with a very large tool log and reusable tool sets, which is a very expensive solution.

Conducting experimental research in the direction of creating innovative technological systems makes it possible to determine the range of use of the proposed new ways to change the properties of materials in order to improve performance, strength and durability of working surfaces of machine parts.

The set of researches results of which are resulted in this monograph, is carried out in laboratories of special methods of processing of working surfaces of details of mechanical engineering. The research involved not only teachers - scientists of the Department of Mechanical Engineering Technology of Donbass State Engineering Academy, but also undergraduate students studying in the educational and scientific program in "Applied Mechanics".

# **CHAPTER 1**

## **PHILOSOPHICAL BASIS OF THE UNIVERSE: MATTER, ENERGY, INFORMATION**

Now, with the advent of the information society, the concept of information is of great interest to researchers in all fields from the humanities to science [1, 2, 3, 4]. The concept of information still has no precise definition. There are many definitions of the concept of information in terms of private science [5].

Depending on the field of knowledge in which the study was conducted, the information received many definitions:

1) Information - is the designation of the content obtained from the outside world in the process of adaptation to it (Wiener), the definition in terms of cyber science [6];

2) Information - denial of entropy (Brillouin), definition in terms of physical sciences [7];

3) Information - communication and communication, in the process of which uncertainty is eliminated (Shannon), definition in terms of theoretical computer science [8];

4) Information - the transfer of diversity (Ashby), the definition in terms of psychology [9];

5) Information - originality, novelty; information - a measure of the complexity of structures (Mol), definition in terms of theoretical chemistry;

6) Information - the probability of choice (Yaglom), definition in terms of probability theory.

Each of these definitions reveals one or another facet of this multifaceted concept. In philosophy there is a similar and somewhat coincides with the concept of information, the concept of entelechy - one of the central concepts of Aristotle's philosophy, which expresses the unity of four causes, or basic principles of existence - matter, form, active cause and purpose.

Aristotle's various definitions of entelechy can be reduced to the

following: the transition from potency (possibility) to organized energy, which itself contains its material substance, the cause of itself and the purpose of its movement or development [10]. In modern times, the concept was used by G. Leibniz, who called his monads entelechy, and received a specific refraction in the vitalist concept of the German biologist H. Drys [11].

Norbert Wiener, the founder of cybernetics, is well aware of the nature of information: "Information is neither matter nor energy. This is the third. "That is, in the world, in addition to matter and information, there is something else, and this is information. According to VM Glushkov, BB Kadomtsev, AD Ursul, YI Shemakin, KK Kolin, "the real world is formed by three fundamental components: matter, energy and information, which are self-sufficient and are different types of manifestations of objective reality, which exists independently of our consciousness "[12].

Ideal reality objectively exists and is the fruit of the interaction of material objects. Information is not a physical object, but for its manifestation needs objects or processes of physical reality, which serve as its carriers [13]. Despite its ideal nature, information can affect material objects.

Physical and ideal reality in the world, are closely interconnected and can have a very significant impact on each other. Reality has the property of dualism, as it simultaneously includes both physical and ideal reality, which, have the properties of mutual reflection.

The concept of information is difficult to understand and define, because it manifests itself in different ways in different conditions: in the physical systems of inanimate nature, in biological systems, in technical devices, in social systems and in human consciousness. Information is multifaceted, so there are so many different definitions and interpretations [14].

If as a result of interaction there are changes in some properties of processes, then these changes should be considered as one of the types of dynamic information.

Physical reality consists of all existing material objects in the world, both tangible and intangible (electromagnetic, gravitational and other fields), as well as all the processes of movement and internal change that occur with these objects.

Ideal reality objectively exists independently of the activity of consciousness and is as important a component of reality as physical. It arises as a result of the interaction of objects or processes of physical reality and is a reflection of the properties of some objects or processes in the structure of others. A fundamental property of physical and ideal reality is the property of mutual reflection, which creates the possibility of manifestation of various aspects of the phenomenon of information [15, 16].

The physical nature of information carriers is not of fundamental importance. The main thing is that they have the ability to perceive information by adequately changing the internal structure (for physical objects) or their parameters (for dynamic processes).

Despite the fact that information belongs to the world of ideal reality, being associated with one physical object (or process), it can affect another object (or process) of the physical world, which becomes its new carrier. Thus, the process of transmitting information from one object or process of physical reality of another object or process is realized. Physical information is an objective property of reality, which is manifested in the heterogeneity of the distribution of matter or energy in space or time, as well as in the uneven flow of dynamic processes in inanimate nature, technical and biological systems. The amount of information is a measure of the complexity of organized systems of any nature and allows obtaining quantitative estimates of the level of this complexity.

Information permeates all levels of organization of matter and energy in the world. It is the root cause of the movement of matter and energy and determines the direction of this movement in space and time.

Information is a multifaceted phenomenon of reality, which manifests itself in a specific way in different conditions of information processes in various information environments of animate and inanimate nature: in natural inanimate nature, technical objects and systems of artificial nature created by man, biological systems and human society and consciousness [12]. However, we can assume that there are some fundamental patterns of information that are common to information processes that are realized in objects, processes or phenomena of any nature. Information as a measure of the orderliness of structures and their interaction is an objective characteristic at all stages of the organization of matter. As an attribute of matter, information participated in the processes of its self-organization, contributing to the emergence of living things and, thus, the formation of homeostasis and the phenomenon of management.

At the heart of the processes of self-development is dialectical unity and the struggle of opposite tendencies: organization and disorganization. Matter has qualitative levels of organization and develops from lower to higher. Relatively stable states of matter form structures, objects of artificial and natural origin. They form structural information. There are processes of interaction between structures. Processes differ in the rate of intensity of information flows that change these levels. It is in the information aspect that the relationship between objects and processes is most clearly manifested.

To understand the relationship of forms of motion with types of matter, the theory of reflection is crucial, as all forms of motion are manifested on the basis of reflective mechanisms. Reflection is a property of material systems in the process of interaction to remember and store in its structure traces of the influence of another system, to accumulate them. This passive form of reflection is inherent mainly in the physical interactions of objects of inorganic nature. Even subatomic particles have certain signs of sensitivity: gravity and repulsion,



atomic valence, molecular bonding.

Reflection is one of the properties of matter, as well as space, time, motion, and is the most important factor determining the nature of interaction. Forms of reflection have historically evolved along with the development of matter. High levels of development of matter have more perfect forms of reflection. The process of improving the quality of the display went along the lines of increasing the activity and selectivity of the display. All products of human cognitive activity are active reflections of reality. Not mass and not energy, but the level of organization characterizes the development of reflectivity systems. Interaction in the inorganic nature occurs on the basis of reflection and specific conditions, as a rule, statistical character therefore not all reflections can be realized in interaction. Elements of the system as a result of reflection and interaction on the basis of the laws of physics and chemistry and probabilistic laws form ordered structures, mostly stable. Reflection in inorganic nature does not have the status of independent existence. But under certain conditions there are processes of spontaneous, slow current self-organization.

Inherent in the inorganic world passive type of reflection is a "genetic prerequisite" and "functional basis" for the emergence of higher forms of reflection in wildlife and human society.

The activity of reflection was manifested in the fact that lower organisms began to have a "purposeful sensitivity". The beginning of the transformation of reflection into a signal-information factor in the catalytic reactions of prebiological systems was the emergence of the rudiments of biological self-organization and self-government. The reflection of the opposing environment in combination with defensive reactions grows into feedback, a closed loop - the basis of homeostasis.

The continuous-cyclic influence of the space-time continuum of the world on stable structures leads to qualitative changes in the organic substance, to the self-improvement of the structure, which is accompanied by an orderly complication of its functional properties. Living organisms begin to extract from

the total effect of the interaction of the information aspect. They respond to diversity by determining the development of complex reactions in the body of the biological system, which predict, anticipate the events of the outside world. Based on the objective function of maintaining its integrity, living systems acquire the ability to respond not only to the absolute magnitude of the effects, but also to the relationship to their parameters. As the level of the organization increases, in order to respond properly and adapt to the environment, the body must somehow record information about changes in this environment, they gradually have the ability to symbolize information. On this basis, a new form of informational causality has emerged. This causality is realized by encoding reactions to past influences and events of the external world, memorizing them in the genetic code with the possibility of use under current influences, in the process of life. This has created new opportunities to combat entropy.

Anticipatory reflection, directly related to adaptation and self-learning on the basis of feedback, further determined the progressive development of living organisms. The main attribute of the living is the specifics of the organization. It consists of two interrelated components - the organization of structural and functional. Substances is orderly complicated, increasing sets of hierarchies, operating on the basis of reflections, feedback in a confrontational environment. The environment is a stimulus for the activity of the system, creates a struggle, creates movement, self-development. In this case, the reflection determines the functional organization [5].

The condition for the existence of information is the presence of a source, communication channel and recipient of information. This applies to operational information. The very structure of objects also contains structural information. It becomes operational when the recipient of information and the communication channel appear.

Operational information is the content of various processes, forms of motion of matter (in the biological form of motion on the basis of self-regulation; in the social - on the basis of information and management

activities). Operational information gives birth to, forms, improve relatively stable structures: biological species, social education, many objects of the noosphere of material and spiritual order. The concepts of "matter", "energy" and "information" are equivalent in level to general scientific philosophical categories. They complement each other and mutually characterize various aspects of the objects, processes or phenomena of physical reality studied by science.

#### Conclusions:

1. The real world is formed by three fundamental components: matter, energy and information, which are self-sufficient and are different types of manifestations of objective reality, which exists independently of our consciousness. They are equivalent in level to general scientific philosophical categories.

2. Information is not a physical object, but for its manifestation needs objects or processes of physical reality, which serve as its carriers.

3. The concept of information is difficult to understand and define, because it manifests itself in different ways in different conditions: in the physical systems of inanimate nature, in biological systems, in technical devices, in social systems and in human consciousness. Information is multifaceted, so there are so many different definitions and interpretations.

4. The amount of information is a measure of the complexity of organized systems of any nature and allows obtaining quantitative estimates of the level of this complexity.

5. Information permeates all levels of organization of matter and energy in the world. It is the root cause of the movement of matter and energy and determines the direction of this movement in space and time.

6. As an attribute of matter, information has participated in the processes of its self-organization, contributing to the emergence of living things and, thus, the formation of homeostasis and the phenomenon of management.

7. Reflection is one of the properties of matter, as well as space, time, motion, and is the most important factor determining the nature of interaction. Forms of reflection have historically evolved along with the development of matter. High levels of development of matter have more perfect forms of reflection. The process of improving the quality of the display went along the lines of increasing the activity and selectivity of the display. All products of human cognitive activity are active reflections of reality. Not mass and not energy, but the level of organization characterizes the development of reflectivity systems. Interaction in inorganic nature occurs on the basis of reflection and specific conditions, usually of a statistical nature, so not all reflections can be realized in interaction.

8. Operational information forms, forms and improves stable structures - biological species, social education, including spiritual structures in the form of the noosphere and planetary consciousness.

## **SECTION 2**

### **PROPERTIES OF THE OBJECT AS A REFLECTION OF THE INTERACTION OF SUBSTANCE AND FIELD**

When considering interaction as a philosophical category, it is important that it reflects the processes of influence of objects (subjects) on each other, their mutual conditionality and the generation of one object to another. Interaction (according to the encyclopedic dictionary) is an objective and universal form of movement, development, which determines the existence and structural organization of any material system.

In statistical interaction, the effects of two (or more) variables are interdependent; for example, the complexity of the task and the level of excitation often interact in such a way that increased excitation leads to an increase in the success of solving simple problems, but reduces the success of solving difficult problems. Research has identified such types of interaction as commonwealth, competition and conflict. It should be borne in mind that these species are not only the interaction of two individuals: they occur both between parts of groups and between whole groups. Thus, in the course of interaction between members of the newly formed group there are signs that characterize this group as an interconnected stable structure of a certain level of development, as a material process accompanied by the transfer of matter, motion and information: it occurs at a finite speed and in a certain space -time. But these restrictions apply only to direct interaction; for indirect forms of interaction, spatiotemporal constraints are repeatedly weakened.

Interaction is the mixed effect of two or more independent variables on dependent variables when they act together. In the study of the effect of variables in the experiment, the individual influence of each of them can not explain the overall change. In such cases, it is therefore advisable to use a statistical test, such as analysis of variance, which is designed to assess the effect of the interaction between variables, as well as the specific effect of each.

From the point of view of the system, interaction is a system of

interdependent individual actions associated with a cyclical causal relationship, in which the behavior of each participant is both a stimulus and a reaction to the behavior of others.

The concept of interaction captures the direct and "reverse" effects of things on each other, the exchange of matter, energy and information between different objects, between organisms and the environment, forms of human cooperation in different situations of cooperation. Interaction covers direct and indirect relationships between objects and systems. Examples of direct interactions are classical mechanics, when it considers collisions and repulsions that transmit motion from one body to another. In the field of society, an example of interaction can be direct communication between human individuals.

Most often, the interaction is identified with direct interaction. Such identification, as a rule, threatens to transfer mechanical schemes of movement to the description of various spheres of reality (organic or social) which are not subject to similar schematization. In social analysis, similar simplifications may arise when trying to interpret social processes according to the schemes of direct interaction between people. Mechanism in explaining nature and psychologism in describing social evolution are largely provoked by the substitution of a detailed interpretation of specific systems of interaction with simplified ideas about direct and immediate interactions. However, the concretization of the concept of interaction is carried out through these concepts. Interaction is defined as the transfer of motion from one object to another, as a change in the qualities of chemicals reacted, as the transmission of messages in human contacts or as a synthesis of various human forces, generating new knowledge, things, organizational structures.

In social processes, interaction is a point of closure and opening of social ties. In other words, the interaction is thus not a starting point, but a recurring moment that maintains the stability of social forms. Given this plan of consideration of interaction, we can no longer talk about individual interactions, but about their series, sequences, systems that ensure the continuity of complex

processes not only in space but also in time. A separate interaction then acts only as a fixed point of multidimensional relationships between objects or human activities, a kind of "stop-frame", which is our observation of the relationship of things or human actions. In the simplest analysis of interaction the interrelation of two objects or two subjects is supposed. Thus, many sociological textbooks begin the consideration of social interactions with the interactions of two or more individuals; that is, it is implied that where more than two interact, the interaction is still built on a simple scheme of subject-subject relationship. However, a closer analysis reveals that the "pure" interaction of the two is an idealization, leaving beyond the "hidden" intermediaries: norms, stereotypes, orientations that go beyond direct contact. In the field of analysis of natural objects and systems, it is also necessary to take into account various kinds of temporal, ensemble, and population dependences, which are not fixed within the framework of direct interactions, when characterizing interactions. In fact, this distinguishes the modern "non-classical" situation of cognition from the classical, formed around a separate interaction of things, which involves a separate subject with a separate act of fixing the interaction. But the more noticeable this difference, the clearer it is that the definition of the cognitive situation by the scheme of individual interaction was a kind of idealization, emphasizing the usual and stable forms of human experience. The simplicity of the experience of human interactions appeared before the given, conditioned, demanding explanations complementing the usual experience. Direct interactions reveal individual properties of objects, but can not always characterize their features, the certainty of their inherent forms of motion. Concretization of ideas about the types of movement, about special sets of interconnected objects, about their qualities is achieved by man through the creation of measuring instruments, concepts of measures, knowledge about the categories of phenomena and ways to compare them. This experience is enshrined in knowledge, which is called scientific. However, it is due to the latter that it becomes clear that ordinary human experience is saturated with

schemes that allow him to include in the perception and understanding of direct interactions generalizing and orienting forms. In terms of the actual philosophical concept of interaction is one of the most important in elucidating the relationship between phenomenology and metaphysics. The key question is the relationship between a person's given situation of his existence and the need for a person to go beyond this fact, to take into account this need in the characteristics of his existence.

Interactions are the starting points of various cognitive situations insofar as they reveal shifts and changes in the states and movements of objects, in the positions, actions and perceptions of man. Interaction, discovering the properties of the objects included in it, at the same time determines the situation of cognition, fixes the cognitive abilities of the subject, his "Premises" in the situation, his involvement in the interaction, and hence his own properties.

Interaction contains a cognitive paradox. On the one hand, it is manifested due to the "inscription" of cognitive person in the situation, on the other hand - it indicates the factors, forces and causes that go beyond the cognitive situation, which do not depend on the subject, causing differences in interaction and its human detection. Given the interaction puts a person in front of the need to take into account their objective properties, which do not depend on his cognitive attitude and his influence on the logic of things. This paradox of interaction is due to the fact that man does not exist in individual acts of events with people and things, but in the sequence, series, interweaving of such acts. He constantly has to move from individual interactions to their clutches and chains, and hence change their cognitive positions, tools and instruments. In fact, he needs to do this in order to see through direct interactions interactions indirect, to master or create tools that include them in systems of relationships wider than those directly given to him. Interaction - participation in common work, activities, cooperation, joint implementation of operations, operations.

Let us briefly dwell on the physical understanding of the structure of the world, where there are four types of interactions. In terms of the structures of the



world, the objects of the world are combined into systems due to interaction with each other. Interaction in a narrower sense means such processes during which between interacting structures and systems there is an exchange of quanta of certain fields, energy, and sometimes information. In nature, there are qualitatively different systems of related objects. Nuclei - related systems of protons and neutrons; atoms - bound nuclei and electrons; macrobodies - a set of atoms and molecules; The solar system is a "bundle" of planets and a massive star; galaxy - a "bundle" of stars. The presence of connected systems of objects suggests that there must be something that fastens parts of the system as a whole. To destroy the system partially or completely, you need to spend energy. "The mutual influence of parts of the system or structural units occurs through fields (gravitational, electric, magnetic and others) and is characterized by the energy of interaction. It is now accepted that the types of any interactions of any object can be reduced to a limited class of four basic fundamental interactions: strong (nuclear), electromagnetic (different source frequencies and corresponding vibrations), weak and gravitational (universal). The intensity of interaction is usually characterized by the so-called interaction constant, which is a dimensionless parameter that determines the probability of processes caused by this type of interaction. Strong and weak interaction is short-lived. The interactions between the structures are transmitted by means of a corresponding field with a finite velocity equal to the speed of light in vacuum. The category of movement and interaction are similar in content.

Achieving an absolute level of compatibility speaks of the multilevel world. Linearity shows us the visible world, and multilevel - real. Visible does not mean real! We must learn to understand that any process of cognition involves a gradual progression from external to internal, ie from 0 to 1. With increasing quality, the number of components increases. This should not be seen as a violation of the law of transition from quantity to quality. On the contrary, it is a confirmation of it.

### **SECTION 3**

## **CHANGE IN THE PROPERTIES OF SUBSTANCES AS A CONSEQUENCE OF CHANGE IN THE INTERACTION OF SUBSTANCE AND FIELD**

According to modern physical ideas, inorganic nature in general is divided into two systems - field and matter. The material essence of the physical field is not yet clearly defined. But whatever the field is, it is generally accepted that it manifests itself in various coexisting, interacting and interpenetrating species. The universe contains a physical field, electron-positron, meson, nuclear, electromagnetic, gravitational and other fields. In other words, it is a system of specific material fields. Each specific field, in turn, is also systemic. But now it is impossible to say with certainty what is an element of a particular field. Obviously, it has certain levels, ie how the system develops, for example, from a "vacuum" to a clear quantum state. The quantum of the field itself is an elementary particle. Therefore, a quantum can hardly be an element of a specific field. Most likely, such elements are nodal "points" of the structure of elementary particles. There is clear experimental evidence for the existence of this structure and a lot of different ways to study it. But what is the structure of the elementary particle, and even more so its nodal "points", remains unclear. If we allow the idea of the particle as the highest form of development of the matter of the field, it is natural to assume the existence of certain "bricks" that form the particle and are what make up the physical field in general, ie elements of the physical field. Their interaction (field form of motion) leads to the "creation" of an elementary particle of one type or another. This idea of the complexity of elementary particles, that each of them is a system consisting of a different number of differently interacting and differently spatially arranged elementary particles, but essentially identical "bricks" of matter, explains the interconvertibility of particles and opens the way to penetration into depth of matter. The elementary particle is not only the quantum of the field, but also what can underlie a qualitatively different system - matter. Substance is an

extremely complex, deeply differentiated multilevel system. If an elementary particle also acts as an element of a qualitatively different material system, then two or more interacting elementary particles represent a system that can be called a particle of matter. Thus, the interaction of a proton and an electron forms the simplest atom of light hydrogen, an intrinsically dynamic system, the elements of which are subject to a number of parameters and, as a result, differ from free particles. The atom as a system develops, becoming more complicated in composition and structure to such a state that the spontaneous decay of the atomic nucleus begins. Interacting atoms form various systems: molecules, macromolecules, ions, radicals, crystals.

A molecule is a material system consisting of certain atoms and one or more chemical elements located in space and interdependent atoms. The bond of atoms in a molecule is more reliable than the bond of atoms to the environment, which ensures the integrity of the system. A molecule is a qualitative material formation in relation to the atoms of which it is composed. Molecules can be simple or complex, containing one, two and thousands of atoms. Giant groups of atoms form macromolecules. However, not all substances consist of systems such as molecules. Some chemical compounds, such as sodium chloride (table salt), do not have molecules in the usual sense of the word. These are open systems in which ions are relatively independent of each other. This type of material system is called a crystal. Ions are considered to be individual charged atoms and groups of chemically bound atoms with an excess or deficiency of electrons. A group of atoms that passes unchanged from one chemical compound to another is defined as a radical. All these groups are systems.

The interaction of atoms of the same type forms a chemical element. Minerals are formed from chemical elements, rocks are formed from minerals, geological formations are formed from rocks, series of formations are formed from geological formations, and the planet Earth is formed from geospheres. Each system, in turn, has its own structure. For example, the atmosphere consists of five subsystems: the troposphere, stratosphere, mesosphere,

thermosphere, and exosphere.

The earth as a planet acts along with other planets as an element of the solar system. In turn, the solar system is part of such a grand space system as the Galaxy. Interacting galaxies form systems of galaxies that are part of the Metagalaxy, etc. Thus at each level of development of the inanimate nature, along with the general, there are also the system-forming factors, special communications and interactions. However, the principle of organizing the set into unity remains the same. It does not change during the transition to wildlife systems. The most important direction in the development of systemic ideas, which have received a comprehensive justification, including space, is the concept of self-organization. In the twentieth century, there was a change in the cosmological paradigm of scientists: from the theory of the Stationary Universe to the theory of the evolving universe. According to the concept of the Big Bang, the universe has found the beginning and processes of self-development, self-organization, ie the dominance of creative cosmic processes over the processes of destruction, extinction of the universe.

## **SECTION 4**

### **MAGNETIC FIELD AND ITS PROPERTIES**

In recent years, there are more and more works to study the effect of magnetic fields on the mechanical properties of metal. In scientific works [49,50] it is noted that the influence of the magnetic field changes the strength, ductility and other mechanical and operational properties of the metal.

When monitoring the technical condition, when carrying out work on in-tube diagnostics, the pipelines of the linear part of the objects of the main transport are exposed to a constant magnetic field. Such a magnetic field is characterized by a low intensity - up to 16 MA / m (140 kE) and the duration of exposure [49], therefore, it is necessary to study the effect of such a field on the mechanical properties of the metal. The authors [51,52] conducted a number of studies and established dependences indicating that the influence of the magnetic field led to an increase in the ductility of steel. In [51], it was determined that in the case of uniaxial stretching, the transverse effect of the magnetic field reduced the elongation of the grains along the direction of deformation. Pipelines of the linear part of the objects of the main transport in the process of operation undergo uniaxial stretching and torsion. In [52], the authors conducted a series of experiments in which the samples were tested for torsion under the influence of an external magnetic field, in the course of the study it was confirmed that the metal formed defects that arose at the initial stage of plastic deformation. The formation of defects was accompanied by partial relaxation of elastic energy. Magnetic characteristics, measured in different magnetic fields, allowed to compare the magnitude of plastic deformation and the degree of damage. As the degree of deformation increased, the "magnetic stiffness" of the samples increased, so the values of coercive force and residual induction increased, and the magnetic permeability decreased. This phenomenon is associated with the difficulty of magnetization of the metal, due to the appearance in the deformable sample of defects with higher values of

critical fields and the interaction of domain boundaries with defects in the structure of the metal. The change in magnetic characteristics occurs even at low degrees of deformation. If we consider this phenomenon as a model, then the coercive force is associated with the density of dislocations, and, as a consequence, with increasing density of dislocations the coercive force will increase. Further increase in magnetic characteristics causes the formation of dislocation walls, which become places of consolidation of domain boundaries [53].

Of great interest are works showing the effect of monotonic dependences on the piezoelectric magnetization of tensile, compressive and torsional elastic deformations. These deformations allowed to register the value of the maximum acting stresses on the change of the piezoelectric magnetization of the pre-magnetized ferromagnet. This phenomenon can be used to "remember" the maximum stresses that acted directly on the material, ie to be an element of "magnetic memory". But even in the presence of this effect, to remember the maximum applied voltage, it is necessary to take at least two measurements, ie before and after the voltage. Any external elastic deformations will affect the residual magnetic moment, and the changing structural state will increase the effect. The softer the material in the magnetic relation, the stronger the influence of elastic stresses and the change in the structural state on the value of the residual magnetization [55].

At thermal influence of an electromagnetic field it is based on existence of gradients of temperature and electric potential - electrostimulation [56] which is defined by specific energy  $d = 1 \times 10^5 - 1 \times 10^6 \text{ J / m}^3$ , it is necessary for unit of volume of the processed material, duration of influence varies. from 1 to 30 seconds In this case, [57] there is an increase in ductility with a slight change in the strength of conductive materials.

One of the possible mechanisms of the phenomenon may be the heterogeneity of the released energy  $c$ , associated with the presence of phases, non-metallic inclusions, concentrators of electric and magnetic fields in the

metal structure. The results of research related to magnetic pulse exposure have shown that under the influence of a strong electromagnetic field there are structural changes in metal products that lead to their strengthening. The structure of the alloy changes, which takes the form characteristic of the annealed structure.

The influence of the magnetic field on different types of metal under fatigue load has been studied in more depth. For example, the number of cycles to fracture increases in the following metals: copper, tungsten. For aluminum samples, the difference between the number of cycles before failure in the magnetic field and without it was not detected. Samples of lead and zirconium alloys break down faster in a magnetic field. The results boil down to the fact that the influence of the magnetic field on the mechanical properties occurs under several conditions, namely, the samples must be in a tense state in order to have the movement of dislocations, these voltages can be both from the external force program and as residual stresses, appeared in the sample during its manufacture. The presence of paramagnetic defects is also required. However, they may be very few, as the dislocation in its movement is quite a long way, so there may be enough background impurities. It should be noted that radiation resistance, or rather its part associated with the movement of dislocations, will also depend on the magnetic field [58,59,60,61].

Ultrasonic propagation velocity (ESD) in metals and alloys was measured to capture changes in materials during deformation and heat treatment [62]. The authors called this method electrical stimulation of metals and alloys, which restores and increases efficiency through treatment with a powerful pulse of electric current. A number of low-cycle fatigue tests were performed on the following steels: X18H10T, 70XFCA, P6M5, 40X, 38X2MFOA, 08Г2C [63]. This study considers the possible relationship depending on the number of load cycles on the basis of the model of the theory of reliability "strength - load". In the process of metal fatigue, the speed of ultrasound decreased due to the appearance of defects and microcracks in the metal. The dependences of the

change of SUZ on the number of cycles and their connection with the data of optical and electronic raster are established. Assessment of the stress level allowed to establish the physical nature of electrostimulation of fatigue recovery. According to the author, the measurement of SUZ, ie processing by an electric impulse, gives the chance to restore durability and reliability of mechanisms.

Data from sources on the effect of magnetic fields on the corrosion rate of the metal are contradictory. In particular, in [64] the experience on corrosion resistance of samples made of 17G1S steel in H2804 solution is described. Some samples were installed between the magnetic poles of the same name, creating an inhomogeneous magnetic field. The results of this study showed that the influence of external magnetic field increased the corrosion resistance by 2.12 times compared with the corrosion resistance of samples in the same environment without the influence of magnetic field. However, the magnitude of the magnetic field and the distribution of its gradient are not specified in the paper.

According to the author [65] and the results of the experiments, it is found that the corrosion rate of steel U10, which is in an inhomogeneous magnetic field, increases, and in the residual magnetized state, the corrosion strength of steel decreases.

However, [65] investigates the effect of residual magnetization on the corrosion rate of a metal. It is indicated that according to the results of the experiment, the magnetized samples are less stable, and their corrosion rate is higher, and the protective effect of the corrosion inhibitor is lower than on the samples without the influence of the magnetic field.

The difference in the appearance of the samples with and without magnetic properties is due to the fact that if the corrosion products are ferromagnetic, they will be washed away in smaller quantities from the metal surface and go into the aqueous phase.

Magnetic, as in any other influence, has its pros and cons.

If the negative impact is to increase the corrosion rate, the positive, according to the author, is to increase the resource as a result of electromagnetic pulse treatment. This effect of material softening under the action of an



electromagnetic field is based on the hypothesis of electron-dislocation interaction [66].

The influence of the magnetic field and the residual magnetization in metals also have a positive effect on the stress-strain state, static strength, ductility.

## **SECTION 5**

### **FEATURES OF VIBRATION MATERIAL PROCESSING**

The natural frequencies of oscillations are an important characteristic of the product. The research allows to use the natural frequencies of the rods to control the degree of hardening, the thickness of the coatings and changes in the physical and mechanical properties of the material over time [17,18].

A review of modern approaches to vibration diagnostics, made, for example, in the work of Heilen W., Lammens S., Sasa P. [19].

Vibration testing is widespread in many fields of technology and there is currently a wide variety of test tools used that are constantly evolving.

Under the means of the experiment is a combination of hardware and software components [21,22,23,24,25]. With their help, alternate selection of harmonic oscillations of each natural tone and measurements in the vicinity of natural frequencies are realized. In addition, their task is also to fix the frequency spectra of test objects in harmonic and nonharmonic excitation. When analyzing the obtained vibration, the signal is pre-represented in the frequency and time domains. Temporal signal analysis allows you to judge the change in signal over time, analyze the change in amplitude, as well as increase the effect of higher harmonics of the signal. Analysis in the frequency domain allows spectral analysis, which makes it possible to detect the effect of individual frequency components on the resulting signal.

Vibration treatment of parts, which allows you to intensify the process of preparation of parts, is as follows. Details and the processing environment are placed in the container to which oscillatory movements - vibrations are reported.

Vibration treatment of parts can be carried out in wet and wet ways.

Vibration processing of details in the abrasive environment is applied.

The process of vibration processing of parts can be easily mechanized and automated.

When vibrating processing, the parts occupy up to 30% of the volume, the filler - up to 60%, the rest of the space remains unfilled.

At vibration processing of details in the conditions of large-scale or mass production it is expedient to create mechanized or automated sites. Such areas should include a vibrating installation of the required size, vibrating screen and vibrating separators, conveyors or monorails with a telfer, hopper, slopes, drying drums. Currently, many plants in the country have implemented vibration processing. The economic effect of the introduction of one vibrating unit is from 1,000 to 8,000 rubles. per year depending on production conditions.

A number of experiments were performed to study the effect of vibration treatment of welding parts on obtaining a high-quality welded joint. The results of experiments on the choice of vibration amplitude show that high-quality welded joints in manual electric arc welding (visually determined) are achieved only when the value of the vibration amplitude is not more than 10 mm.

Modern machines for vibration processing of parts work mainly in the resonant mode, which is characterized by minimal force acting on the vibrator bearings and elastic connections, and a fairly high stability.

The designs of devices and technology of carrying out vibration processing of details in the course of welding are developed, allowing to increase accuracy of manufacturing of cases of oil refining devices from low-carbon steels.

Now most machines for vibration processing of parts work from an unbalanced vibrator driven by an electric motor. However, these vibrators have a number of disadvantages.

Mechanical, chemical and electrochemical methods of surface treatment are used to prepare the surface of the products before coating. Machining includes grinding, polishing, creasing, sandblasting, hydroabrasive, vibrating treatment of parts, etc. Machining is carried out if, along with cleaning the surface from corrosion products, it is necessary to obtain a surface of higher purity.

Mechanical, chemical and electrochemical methods of surface treatment are used to prepare the surface of products before coating. Machining includes grinding, polishing, creasing, sandblasting, hydroabrasive, vibration treatment of parts, etc. Machining is carried out if, along with cleaning the surface from corrosion products to obtain a surface of higher purity.

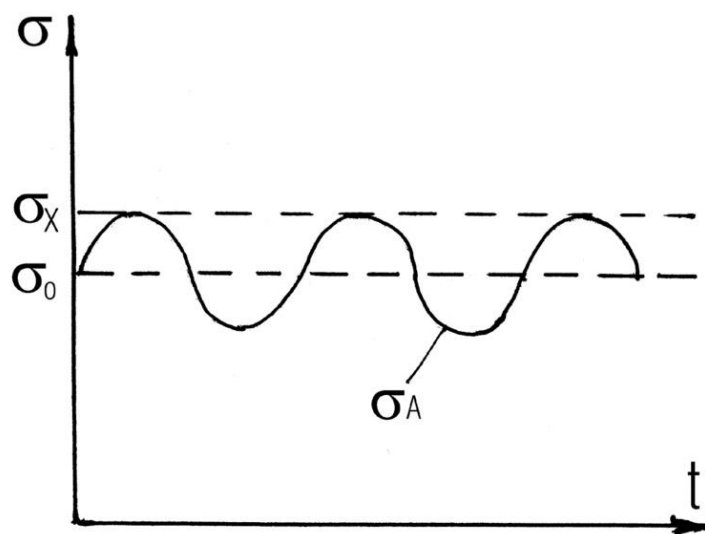
Thermal and mechanical methods are used to reduce residual stresses.

The essence of heat treatment of steels is a change in the grain size of the internal structure of steel. Strict adherence to temperature, time and speed at all stages, which directly depend on the amount of carbon, alloying elements and impurities that reduce the quality of the material. During heating, structural changes occur, which during cooling occur in the reverse sequence [77].

But as production practice shows, housings often turn out defective after heat treatment. Therefore, the latest methods of residual stress removal should be considered.

Stabilization of geometric dimensions of metal structures is carried out by heat treatment (tempering, firing) or mechanical loading (static, vibration).

At vibration loading sum up alternating stresses  $\sigma_A$  with residual stresses so in a metalwork (fig. 5.1.)



*Figure 5.1 - Scheme of summation of residuals and vibration stresses in metal structures*

Under the action of total stresses  $s_x$  plastic deformation can occur, which contributes to the stabilization of geometric dimensions, redistribution and reduction of residual stresses.

If the stresses  $s_x$  are small, then the macroplastic deformations of the weld metal do not occur, and therefore there can be no significant redistribution and reduction of residual stresses of the first kind. After treatment in such modes, as a result of annihilation, the total density of mobile dislocations decreases, and the remaining dislocations are so fixed that it takes considerable effort to move them out of place [78]. In General, this increases the resistance of the weld metal to subsequent involuntary deformation.

To automate the manufacture of body parts and the development of innovative technological automatic robotic complex, it is necessary to introduce the latest equipment that will reduce the auxiliary transportation time and automate the technological process of manufacturing combines k.k.d.

The new equipment will allow concentrating operations on one workplace. New specialized workplaces with the use of manipulators (robots) with special tools, will automate the assembly of combines k.k.d.

After a detailed analysis of the technological process of manufacturing combines k.k.d., the latest block diagram of the production of combines k.k.d. (Fig. 5.2).

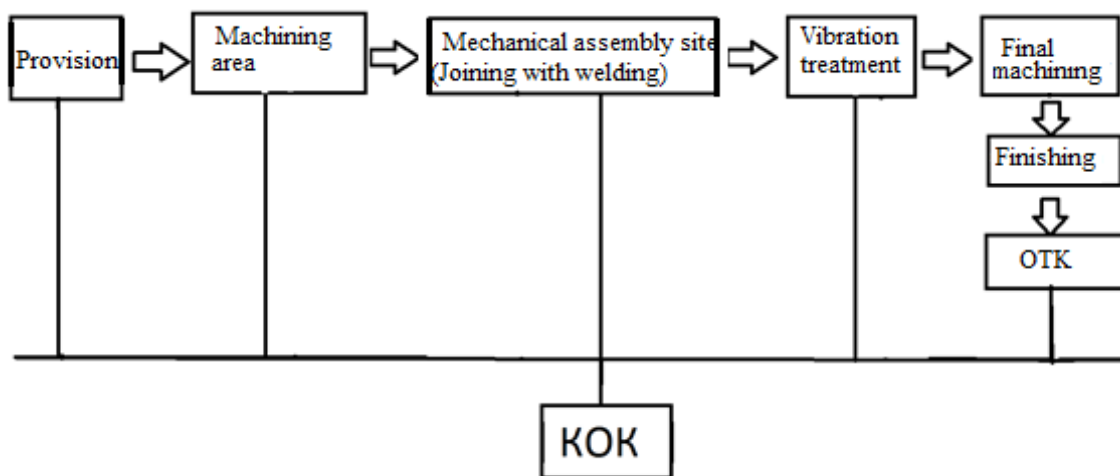


Figure 5.2 - Block diagram of the latest production of combines k.k.d.

Figure 5.2 shows an innovative block diagram of the manufacture of combines k.k.d. The procurement site is placed first, after the procurement works the parts are sent to the machining site. The latest equipment designed for automatic machining of parts is designed at the machining site. Then the parts are sent to the assembly site. The welding section was combined with the mechanical assembly. This significantly reduces the time for moving parts.

Thanks to manipulators (robots) welding takes place on specialized assembly robotic places. Then there is a vibration treatment to remove residual stresses in the body of the combine. The basic version was heat treated.

Vibration treatment is used instead of heat treatment, which is about 10 times more economical and has a number of significant advantages:

1. The equipment necessary for vibration processing is compact, portable and universal for various designs.
2. The cost of equipment, its maintenance and care is small.
3. The process of removing welding stresses proceeds quickly (yes, the maximum processing time of a large enough part weighing 50 tons is 0.5 hours).
4. The surface of a detail at processing does not change (there is no formation of scale, color of a surface does not change).

The method of removing residual stresses by vibration has certain disadvantages, which include the dependence of the efficiency of the method on the material and shape of the part. For example, vibration does not affect the residual stresses of some aluminum alloys. The best results are obtained on steels with high or low carbon content, as well as on stainless steels. The method is not suitable for parts in which the resonant frequency is higher than the maximum frequency of the generator (short parts with a high torque) [79].

The end result of vibration treatment is a function of the values of alternating stresses generated by vibration and the characteristics of the elastic-plastic properties of the metal under cyclic loads [80].

A detailed analysis of the production of housings of combines k.k.d. increased operational reliability in the shop № 7. Based on the analysis,

decisions were made on an inefficient way to remove residual stresses in the body of combines k.k.d. A new method of vibration treatment instead of heat treatment was introduced in the production technology. Since after heat treatment, 20% of the parts were sent for culling. The selected method is more economical by about 10 times and has a number of significant advantages:

1. The equipment necessary for vibration processing is compact, portable and universal for various designs.
2. The cost of equipment, its maintenance and care is small.
3. The process of removing welding stresses proceeds quickly (yes, the maximum processing time of a large enough part weighing 50 tons is 0.5 hours).
4. The surface of a detail at processing does not change (there is no scale formation, the color of a surface does not change).

In particular, an analysis of patents for a special part of the project, selected a method of removing residual stresses in the body parts of combines k.k.d.

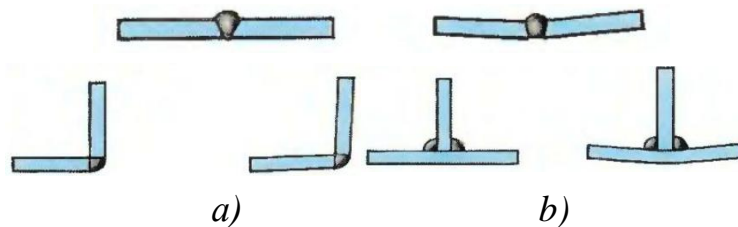
The scheme of the newest innovative automated production of combines of efficiency of the increased operational reliability was developed.

The economic efficiency of the application of the principles to the design of the complex, with the use of the latest mechanical assembly equipment, safety measures at the mechanical assembly site are considered.

Residual stresses lead to distortion of products and semi-finished products during machining, cause the formation of cracks, change the behavior of structures under static and variable loads and promote corrosion cracking under stress. Distortion during machining is associated with the redistribution of residual stresses. In the first approximation, this process can be attributed to the fact that along with the layers removed during machining is carried and some share of the internal load caused by internal stresses. At the same time the existing balance of internal forces is broken and the new that is followed by a bend and change of the sizes of a product is established.

When heated under hardening to a high temperature, the residual stresses are almost completely removed. When quenching due to abrupt cooling and the resulting uneven cooling along the cross section of the products appear quenching residual stresses. The magnitude of hardening stresses depends on the properties of the alloy, cooling rate, size and configuration of the products. The problem of hardening stresses becomes especially acute at processing of large-sized semi-finished products.

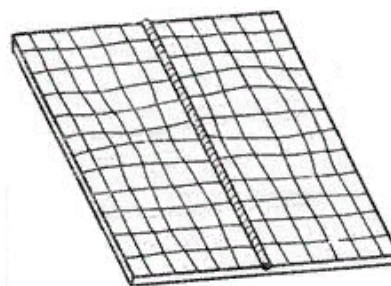
It is known that the main reason for changes in the welded joint, which also results in changes in geometric dimensions, is the presence of residual stresses that inevitably occur during welding [70,71,72,73]. Figure 5.3 shows the principle of stress generation: before welding, the position and size of the plates do not change, but under the action of welding can be observed distortions along the weld, which have a negative impact on the final result of welding structures.



*a - before welding; b - after welding*

*Figure 5.3 - Sample plates*

The formation of residual stresses in the welded parts of the structures can be carried out according to the scheme shown in Figure 5.4.



*Figure 5.4 - Influence of residual stresses of welding parts on geometric parameters*



The diagram of the distribution of residual stresses in these parts, mass  $m_1$ ,  $m_2$ ,  $m_3$ , respectively, can be represented as in Figure 5.5, where, based on the equilibrium stress conditions  $\sigma$  is the complex nature of their change along the direction  $li$ .

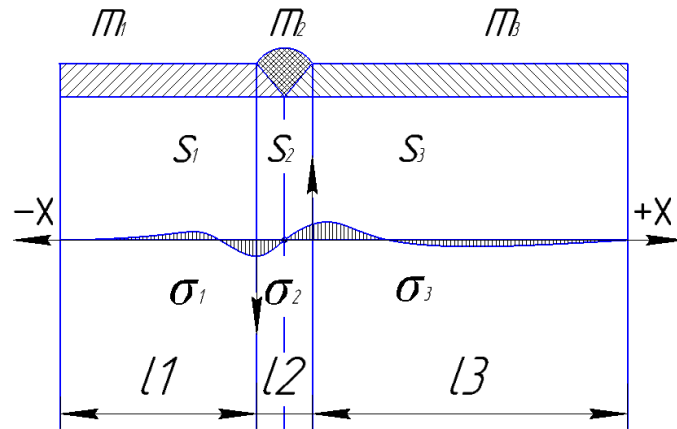


Figure 5.5 - Residual longitudinal stresses in the cross sections of the welded joint

$$\int_0^{l_1} \sigma_1(x) dx = \int_0^{l_3} \sigma_3(x) dx = \int_{-l_{21}}^{+l_{22}} \sigma_2(x) dx = 0 \quad (5.1)$$

$$S_1 = \int_0^{l_1} |\sigma_1(x)| dx \quad (5.2)$$

$$S_3 = \int_0^{l_3} |\sigma_3(x)| dx \quad (5.3)$$

$$S_2 = \int_{-l_{21}}^{+l_{22}} |\sigma_2(x)| dx \quad (5.4)$$

$$S_1 \neq S_2 \neq S_3 \quad (5.5)$$

$$\sigma_{1max} \neq \sigma_{2max} \neq \sigma_{3max} \quad (5.6)$$

$$l_1 + l_{22} = l_2 \quad (5.7)$$

$$f_{1p} = k_1 \cdot \sqrt{\left(\frac{\sigma_1}{m_1}\right)} \quad (5.8)$$

$$f_{2p} = 2 \cdot \sqrt{\left(\frac{\sigma_2}{m_2}\right)} \quad (5.9)$$

$$f_{3p} = k_3 \cdot \sqrt{\left(\frac{\sigma_3}{m_3}\right)} \quad (5.10)$$

To reduce residual stresses, it is proposed to use the polyfrequency method of vibration stabilization treatment in contrast to heat treatment [74]. Traditional vibration treatment of a stressed structure allows to reduce residual stresses by an average of 35%, which in comparison with heat treatment reduces residual stresses by 25... 30%, although this figure is less, but more profitable given the time and energy [75,76 ].

The experimental study involves the study of the acoustic spectra of free oscillations of the experimental samples and the establishment of the values of the resonant frequencies of each part of the sample. Taking into account the dependences, note the frequencies of forced technological vibration oscillations to reduce the residual stresses under the condition of simultaneous exposure to these vibrations with frequencies  $f_{1p}$ ,  $f_{2p}$ ,  $f_{3p}$ .

### **The method of the experiment**

1. Prepare samples for experimental research.
2. Using an audio signal generator with frequency response type "white noise" and piezo emitters, which excite the elements of the sample with their own oscillations.
3. Record the frequency response of the natural oscillations of the sample elements using a sensor consisting of a piezo element and a low-frequency amplifier [73,74].
4. Record the frequency response of the unexcited sample.

5. From the digitized frequency response of the excitation element of the sample to identify the digitized frequency response of the non-excited sample in order to find the frequency response of the natural oscillations of the sample elements, excluding the influence of the means used.

6. Determine the maximum values of the frequency response amplitudes of the resonant frequencies of the sample elements.

7. Carry out simultaneous processing of the sample elements and their natural resonant frequencies, using two sinusoidal signal generators corresponding to the resonant frequencies.

8. Record the shift of the maximum resonant frequencies.

9. Determine the residual stresses  $\sigma_1$  and  $\sigma_3$  on the basis of the dependences (5.8)... (5.10):

$$\Delta\sigma_1^3 = \left(1 - \frac{f_{1pH}^2}{f_{1pH}^2}\right) \cdot 100\% \quad (5.11)$$

$$\Delta\sigma_3 = \left(1 - \frac{f_{3pH}^2}{f_{3pH}^2}\right) \cdot 100\% \quad (5.12)$$

A sample of the welded joint was prepared for the experiment (Fig. 5.6). A sample of the welded joint was installed on the test bench. For better quality and accuracy of the experiment, the sample was fixed with a bolted connection.



*Figure 5.6 - Sample of welded joint*

To create the variability of the loaded states with a wooden wedge marked with three load forces of the welded joint, from the minimum value to the maximum possible in this experiment.

As you know, the main reason for changes in the weld, which also results in changes in geometric dimensions, is the presence of residual stresses that inevitably occur during welding. Figure 5.5 shows the principle of stress generation. Prior to welding, the position and size of the plates do not change, but under the action of welding can be observed distortions along the weld, which have a negative impact on the final result of welding structures.

From the point of view of the surface formed by the two welded specimens, the effect of residual stresses of each of the welded parts on each other is observed.

To increase the stability of the geometric dimensions of welded structures, they are often subjected to general heat treatment (tempering), which requires high energy costs.

Based on the results of deformations of welded structures under the action of residual stresses in recent decades, a low-energy method of stabilizing the geometric dimensions of metal structures called "vibration treatment" has become widespread.

Vibration treatment is carried out by excitation in the welded structure of low-frequency mechanical vibrations.

In terms of energy consumption, vibration stabilization is tens of times lower than heat treatment, and in terms of productivity it significantly exceeds it. Capital expenditures are also reduced by about an order of magnitude.

Welded structures are subjected to vibration treatment not only of carbon steels, but also made of aluminum and titanium alloys. Vibration treatment of cast iron and steel castings is widely used.

Low energy consumption of vibration processing systems, relatively low cost of technological equipment and simplicity of its service allow to apply

vibro-stabilization effectively not only at the big enterprises, but also in the conditions of small and average productions.

Despite the presence of many separate publications on the problem of vibration processing, the general literature on this topic is virtually absent.

Vibration of welded structures at low load levels ( $> 0.05 \text{ St}$ ) has little effect on the change of residual stresses of the first kind [80,81,82]. At the same time, a significant increase in the stability of geometric dimensions due to the redistribution of dislocation densities and changes in stresses of the second kind has been experimentally confirmed.

Based on this, the total load exceeds the yield strength of the metal, i.e. the main process in the welded joint is macroplastic deformation, which can both increase and decrease the residual load.

Therefore, it was proposed to conduct a study to identify the parameters of vibration processing, which can be corrected using the method of acoustic diagnostics, flaw detection.

There are two subgroups of acoustic methods of non-destructive testing: active and passive.

Active methods include methods based on the emission of an acoustic signal (probe pulse) in the object of control (OK), and the study of the transmitted signal and / or reflected signal [83,84].

Passive methods include methods based on the registration and study of signals formed as a result of the passage of certain physical processes in the object of control (for example, the development of cracks under load). Passive methods are also called acoustic emission methods [83,84].

The efficiency of vibration processing depends on the magnitude of the amplitude of alternating voltages and the time of vibration load [85,86,87].

Figure 5.7 shows a welded sample, two plates of different sizes. At this stage, the natural oscillations of the first plate (see Fig. 5.7) and the second plate (Fig. 5.8) are recorded.



*Figure 5.7 - Fixation of natural oscillations of the first plate by means of the emitter "white noise" and the receiver*



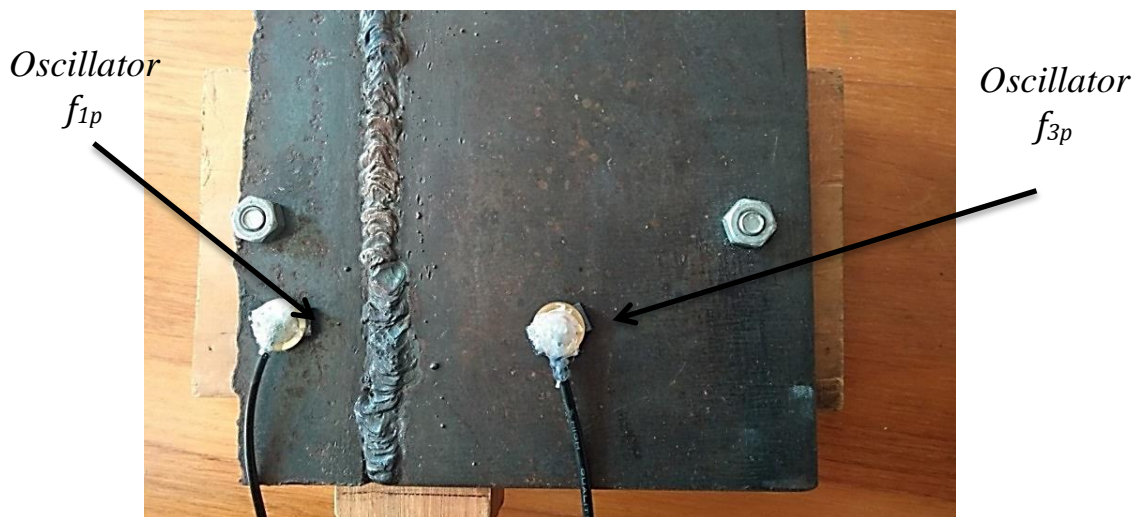
*Figure 5.8 - Fixation of natural oscillations of the second plate by means of the emitter "white noise" and the receiver*

For each of the plates using the software product "Spectrum Analyzer" received data for plotting resonant frequencies. Resonant frequencies were determined on the graphs.

Then the emitter and receiver are placed first on the first plate. A "white noise" signal at the resonant frequency is applied to the emitter, and a new spectrum of resonant frequencies is measured.

After the vibration effect, changes in the first plate are graphically noticeable - its resonant frequencies decrease not only in amplitude, but also in their number.

However, changes in the state of residual stresses of the first plate have an effect on the frequency response of the second plate, its resonant frequencies were changed due to vibration stabilization treatment of the first plate, which was checked (Fig. 5.9).



*Figure 5.9 - Checking the frequency response of the plates after vibrostabilization treatment of the first plate*

To consider in detail the change in the state of influence between the components of the welded joint, the plates, the sample was studied, but with a different effort (Fig. 5.10).



*Figure 5.10 - Adjusting the impact force on the tested welded joint*

After checking the plates with a new effort, it was found that during vibrostabilization processing at the resonant frequency, both in the first and in the second case, the alternation of plates alternately reduces the residual stresses in the processed plate and slightly changes the residual stresses in the other. exceed the stresses recorded before the vibration stabilization.

Comparing the frequency response in Figures 5.11 and 5.12, we can conclude that the residual stresses decreased approximately 2 times after treatment for 2 minutes compared to the initial state of the weld in the structure.

However, there is a clear relationship between the process of vibration stabilization, processing time and the nature of processing, ie not only the resonant frequency of the individual part that comes into contact with the weld, affects the results of the experiment, but also the nature of processing, namely stepwise processing has a positive effect. , but there is a place of dependence of all parts that have direct contact with the weld, and it makes sense to vibrate processing of all parts of the weld in places of their local contact with each weld separately.



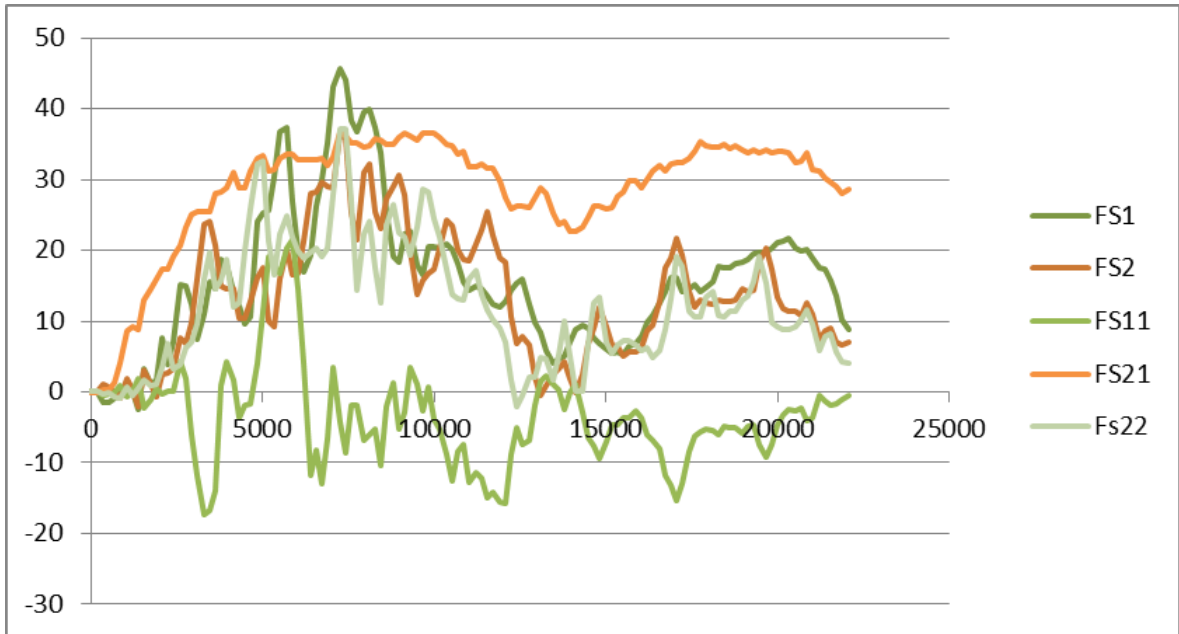


Figure 5.11 - Frequency response of controlled welded structures of two plates before vibration treatment

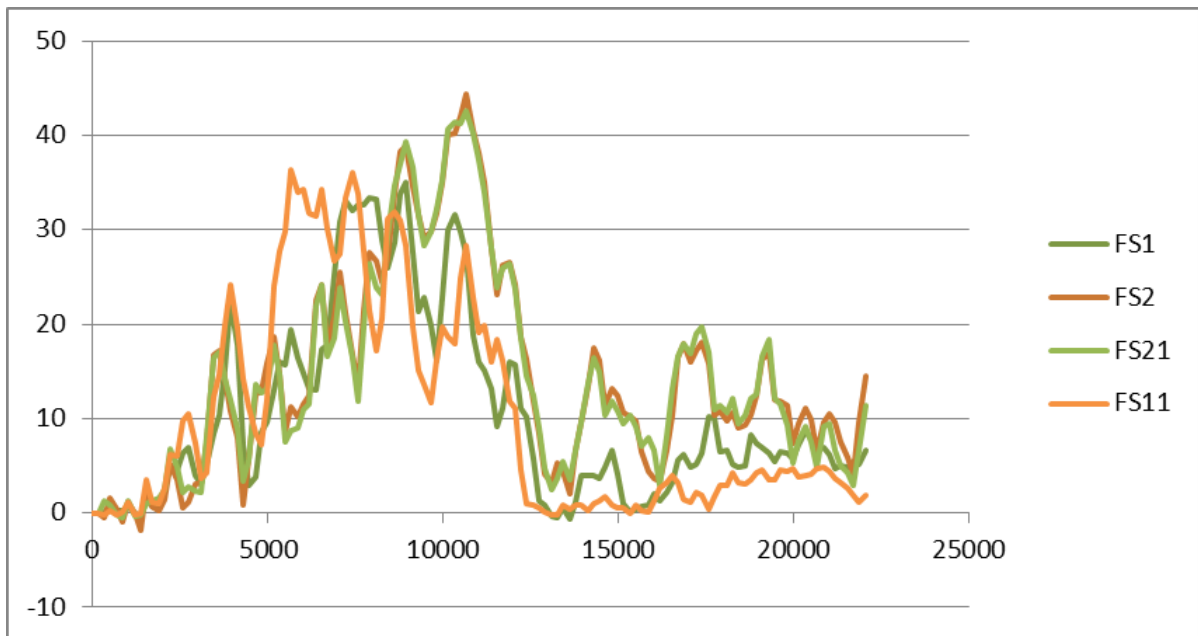


Figure 5.12 - Frequency response of controlled welded structures of two plates after vibration treatment

From the analysis of frequency response data before and after vibration treatment at resonant frequencies and the results obtained by formulas (5.11) and

(5.12) we have that  $\Delta\sigma$  and  $\Delta\sigma_3$  on experimental samples is 22... 25 and 48 (51%, respectively).

The existing problems of residual stress processing in welded structures are determined. Methods of residual stress reduction are considered. The analysis of literature sources showed the existing methods of processing welded structures. Then the vibration method of residual stress reduction was considered, namely the method of vibration stabilization treatment. During the experiment, the results were given, which with the help of the acoustic method of verification make it possible to assess at which frequencies it is necessary to carry out vibration stabilization. Recommendations for the practical use of residual stress reduction technology in welded structures are also given.

The development of a method for testing and conducting an experiment on samples showed a great importance and relationship between the verification of resonant frequencies in the sample and processing by vibrostabilization of samples at resonant frequencies. For implementation in production, you can choose several options for vibration processing of parts.

Figure 5.13 shows the most common scheme of vibration treatment of welded structures [88]. The welded structure 1 is mounted on vibration-insulating supports 5, it is attached to the clamps or bolts vibrator 3 with adjustable oscillation frequency.

On the control panel 4 of the vibrating installation there are devices that register the frequency and amplitude of oscillations by means of a sensor 2 attached to the welded structure. The resonant frequencies of the "welded structure - vibrating exciter" system are registered by a smooth change of the oscillation frequency from the minimum to the maximum. Then perform vibration processing at selected resonant frequencies.

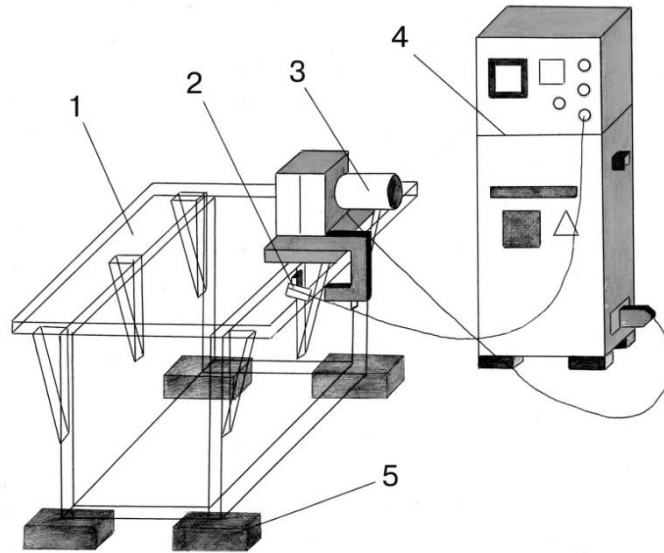
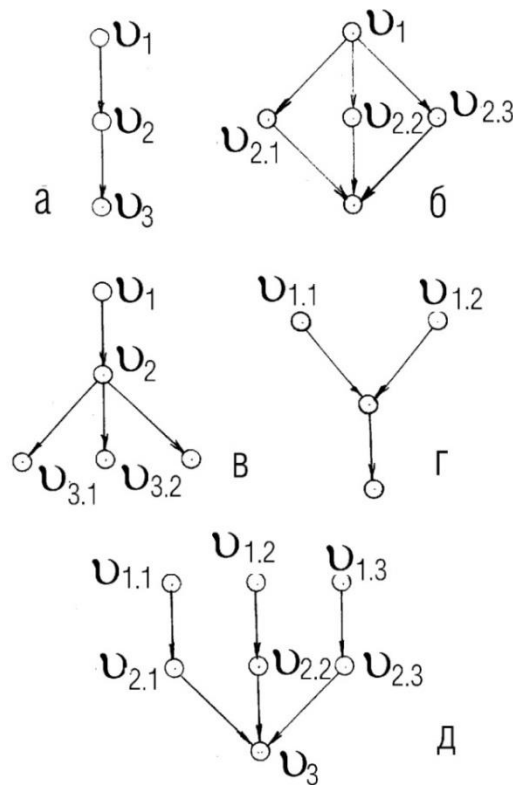


Figure 5.13 - Scheme of vibration treatment of welded structures



$V1, V1.1, V1.2, V1.3$  - energy sources;  
 $V2, V2.1, V2.2, V2.3$  - vibrators and other types of tools  
 $V3, V3.1, V3.2, V3.3$  - objects of processing

Figure 5.14 - Block diagrams of technological processes of vibration processing

Figure 5.14, and shows a block diagram of the considered basic technological process of vibration processing [89]. The electrical energy received from the network, converted into a power supply V1, enters the electric motor of the vibrator V2, where it is converted into mechanical energy, which is transmitted to the product V3.

Vibration treatment of welded structures of different stiffness, as a rule, is carried out by the application of bending oscillations, which create vibrators of mainly inertial type. In such vibrators excitatory forces are obtained by rotating one or more unbalanced masses. Occurs when the shaft rotates the centrifugal force  $Q_0$  is constant in magnitude, but continuously changes its direction:

$$Q_0 = m r \omega^2,$$

where  $m$  is the mass of the imbalance;

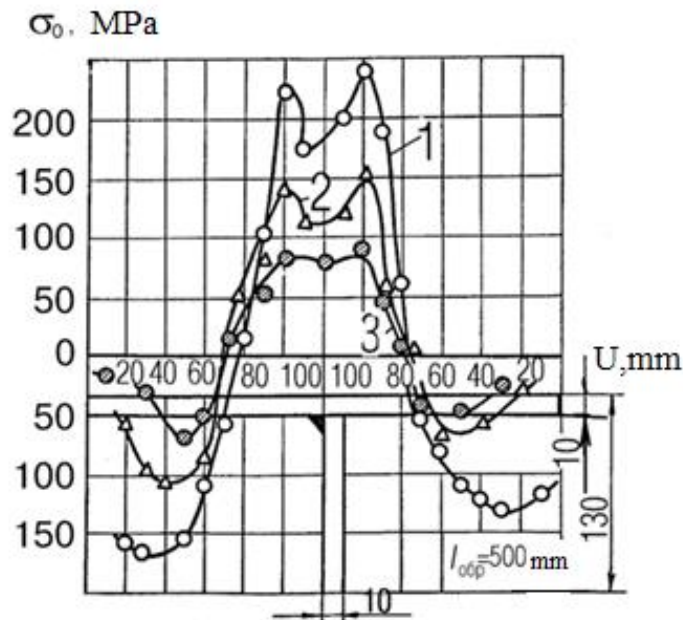
$r$  is the distance from the axis of rotation to the center of gravity of the imbalance;

$\omega$  is the angular velocity of rotation of the unbalance.

In the analysis of vibration processing processes, the welded structure V3 is considered as an oscillating system with distributed parameters and concentrated mass.

The efficiency of vibration processing depends on the magnitude of the amplitude of alternating voltages and vibration load time [90,91,92,93]. The increase in the excitation force is possible by changing the speed or mass of the imbalance. In the case of using the vibration exciter of the inertial type with increasing speed significantly increases the load on the bearings, which dramatically reduces their reliability. The mass of imbalance has a similar effect. Therefore, the excitation force of most inertial vibrators is usually limited to 15... 17 kN.

Vibration load in the welding process is a very effective means of reducing residual stresses and strains in welded structures [94,95,96].



1 - after welding without vibration loading;

2 - after vibration loading during welding and within 10 min after arc breakage;

3 - after vacation at a temperature of 600 with exposure in the oven for 2 hours.

Figure 5.15 - Influence of different processing methods on residual stresses in welded samples

By means of vibration in the welding process improve the formation of seams, increase their resistance to the formation of pores and crystallization cracks [94,96,97], as well as mechanical properties and other performance characteristics of welded joints [94,96,98].

The main parameters of vibration processing are the amplitude and time of vibration load [80,85,93,98,99,101]. The higher the amplitude of alternating voltages, the more intense the relaxation of residual stresses [80,85,93,99].

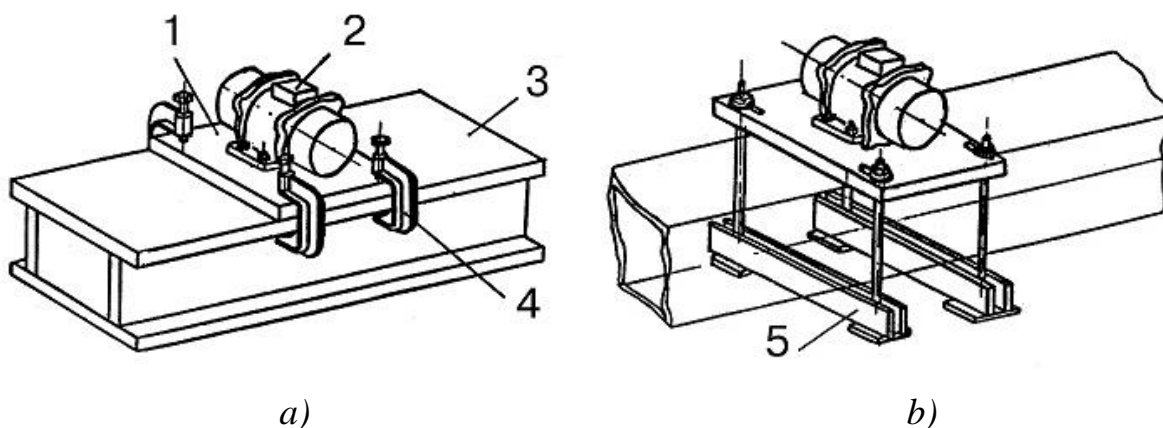
Amplitude-frequency method of controlling vibration processing modes is used when using both unbalanced and electromagnetic vibrators.

In the construction of electromagnetic vibrators used short-stroke electromagnetic mechanisms with an amplitude of oscillations up to 5 mm. A two-gap electromagnetic vibrator develops a dynamic force of 10 to 2,000 N [101].

The efficiency of vibration processing systems is determined by the scheme of oscillation excitation in welded structures. The following basic schemes of excitation of oscillations which provide: installation of details on vibrosupports, suspension of details on a hook, placement of details on the vibrostand, processing in a statically loaded condition with imposing of permeable vibrating force became widespread.

The correct installation of the vibrator is determined by the presence of resonance of the system "vibrator - the workpiece" in the range of its frequency. In the absence of resonance it is necessary to change the place of installation of the vibrating exciter. If at the repeated change of a place of installation of the vibrating excitation phenomenon the resonance phenomenon is not found, increase balances of effort of the vibrator or expand the range of frequencies of influence by application of the corresponding vibrating installations.

The vibrating exciter is attached to the product using clamps from the set of vibrating installation (Fig. 5.16, a). In the absence of a place on a product convenient for reliable fastening of the vibrator by clamps, use the special equipment allowing to establish and fix the vibrator in the set position (fig. 5.16, b).



*1 - plate of the vibrator; 2 - vibrator; 3 - product;  
4 - clamp; 5 - coupling device  
a - clamps, b - coupling bolts*

*Figure 5.16 - Mounting vibrators*

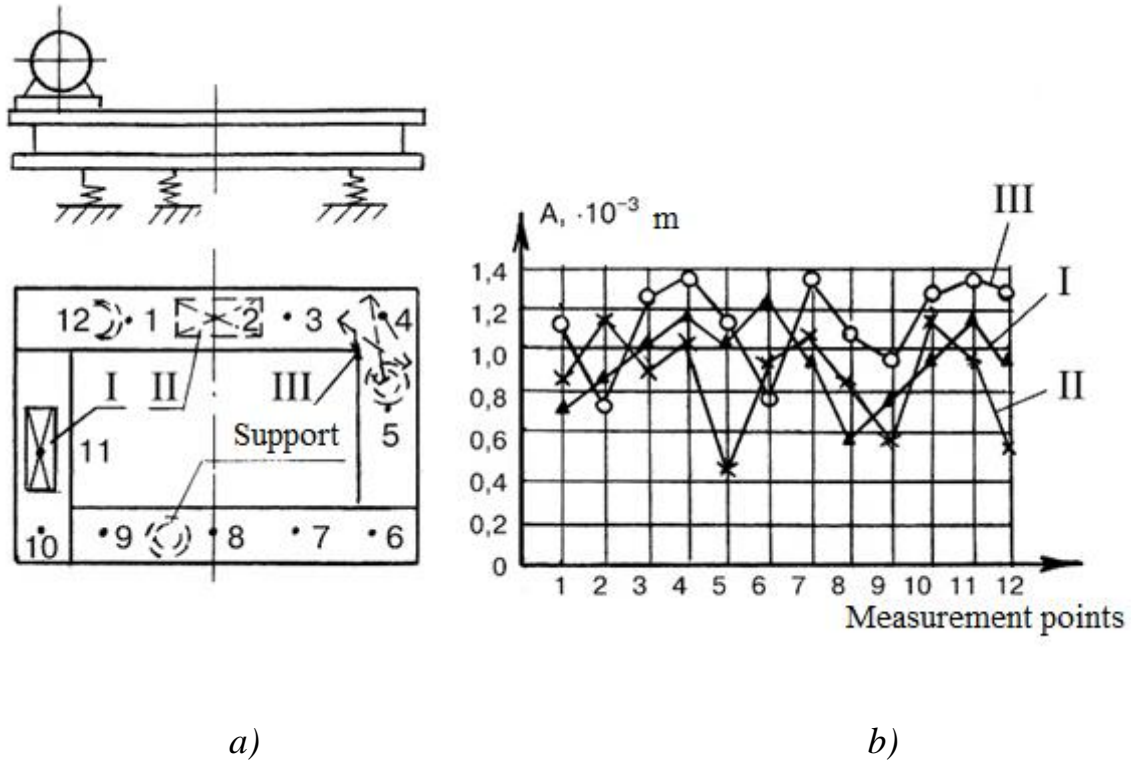
The minimum number of vibrosupport is 3 units, except in some cases of vibration treatment of beams and other rod structures. The bearings oscillate with the maximum amplitude, due to the small contact surface with the part and low damping. Important for achieving high amplitudes are the correct definition of vibration nodes, which are observed in resonance conditions and are lines with small displacements, as well as installation on these lines of supports and the vibrator.

Nodal lines are areas of the product in which there is virtually no vibration at the time of resonance, ie these are the lines around which oscillations occur. They are determined using vibration measuring devices, as well as by filling the surface of the workpiece with sand or other granular material, which under the action of oscillations is collected at the nodes.

Given the specifics of vibration processing associated with the formation in the product of zones of antinodes (a set of points with a maximum range of vibration) and nodal lines (with fixed points), are of interest to study the patterns of interaction of the system "vibrator-welded structure-support" [76] .

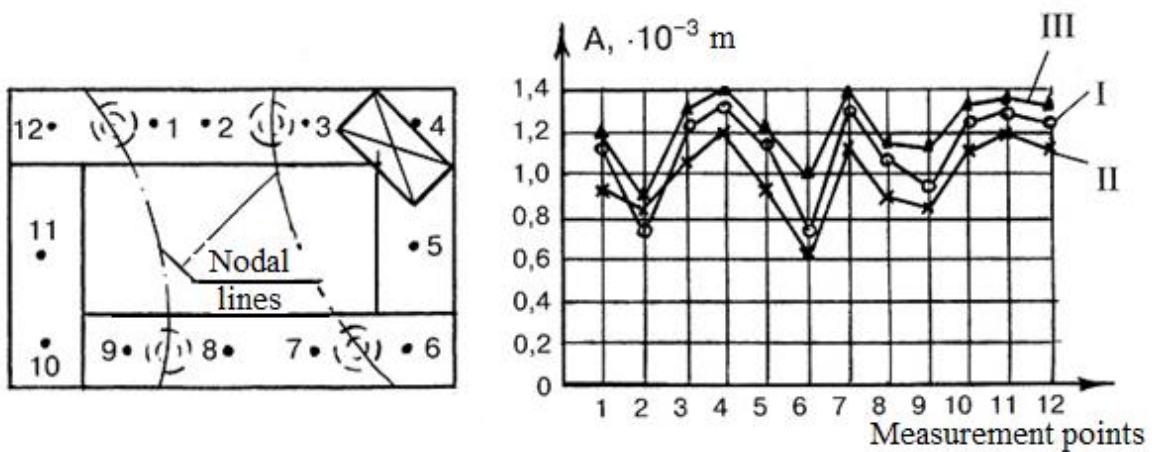
The amplitudes of oscillations of different points of the frame at the location of the vibrator in zones I, II and III, having different bending stiffness, are shown in Figure 5.17. Vibration load at the location of the pathogen in the most rigid part of the frame allows you to achieve the maximum value of the amplitude in the largest number of measuring points, which contributes to the complete reduction of stresses.

Figure 5.18 shows the curves of changes in the amplitude of oscillations depending on the order of the supports. Curve I corresponds to the vibration load at the location of the supports along the nodal lines, curve II - under the zones of antinodes, and curve III corresponds to the location of the supports between the nodes and antinodes.



*a - location of the vibrator; b is the amplitude of oscillations of the frame points*

*Figure 5.17 - Influence of the location of the vibrator on the amplitude of oscillations of the points of the frame*



*a - location of supports; b - amplitude of oscillations*

*Figure 5.18 - Influence of the location of supports on the amplitude of oscillations*

Therefore, by rationally arranging the supports and the pathogen, it is possible to increase the level of energy impact on the treated welded structure.



The vibrator is installed on the surface of the part so that the axis of rotation of the shaft remains horizontal, and the direction of the oscillation waves is parallel to the main welds. The correctness of the installation of the vibrator is determined by the presence of resonance of the system "vibrator-workpiece" in the frequency range. In the absence of resonance it is necessary to change the place of installation of the vibrating exciter. If at the repeated change of a place of installation of the vibrating exciter the phenomenon of a resonance is not found out, increase balances of effort of the vibrator or expand range of frequencies of influence by application of the corresponding vibrating installations.

The SITON equipment allows to carry out measurement of mechanical stresses (technological residual and operational) in metal of a surface layer of a product by a non-destructive method of AFCH-testing. The equipment includes a portable module, a special electrical contact sensor and a personal computer (Fig. 5.19, 5.20).



*Figure 5.19 - Appearance of SITON-ARM equipment*

The AFC-testing method is implemented by passing an electric current of alternating frequency through the investigated area of the surface.



*Figure 5.20 - Appearance of the device SITON-PP*

The portable module automatically controls the frequency of the measuring signal. A special algorithm allows the measured electrical quantities to determine the value of the average voltages  $B_i$  - slo with subsequent conversion into Voltage integral and actual voltages. Scanning is carried out on 3... 24 steps depending on modification of the device. There is quite a lot of experience in the use of equipment in machine-building enterprises of various profiles.

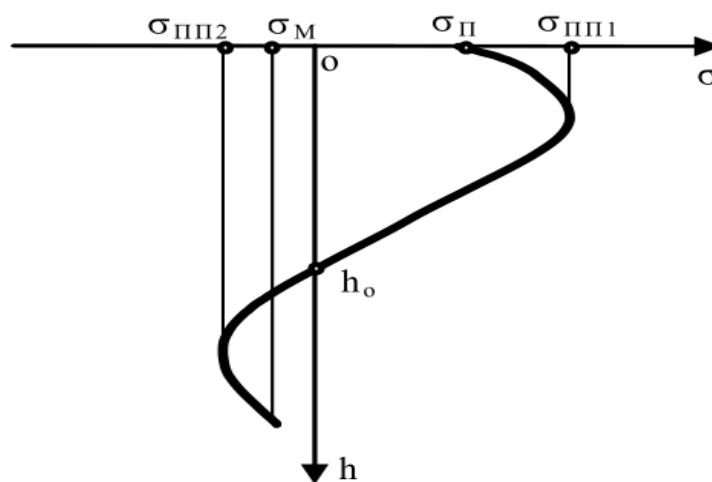
SITON equipment has the following main purposes:

- Determination of non-destructive method of residual and operating stresses  $\sigma$ , MPa in the surface layer of metals and alloys at depths  $h_1$   $h_2$   $h_{max}$ ;
- Continuous non-destructive testing of responsible products; technology stability control; rejection of products; quality control of welded joints;
- Increasing the safety of operation and certification of the stress - strain state of highly loaded metal structures, forecasting the residual life.

Currently, the equipment has two basic versions. Stationary device SITON-ARM. A multifunctional mobile device (Fig. 5.19) connected to a computer. The number of stages of scanning for the basic version 24. The estimated error in determining the mechanical stresses 20 ... 40 MPa. Base of measurement of 35 mm. The maximum depth of stress determination is 2.5 mm

(for steels). The electronic unit can operate in data collector mode. To do this, it has a built-in stand-alone power supply. Up to 250 measurements can be taken in this mode.

SITON-PP portable device. Autonomous device (Fig. 5.20), works in the mode of the data collector with their subsequent transfer to the computer. The number of stages of scanning for the basic implementation 4. Estimated error in determining the mechanical stresses 20 ... 60 MPa. Base of measurement of 35 mm. The maximum depth of stress determination is 2 mm (for steels). Battery life 2 hours. The nature of the distribution of residual stresses is evidenced by the plot of stresses (Fig. 5.21):



*Figure 5.21 - Special points on the plot of residual stresses*

To compare plots as functions, it is necessary to use a special ratio and functionality.

The order of performance of work

For practical purposes, it is more convenient to parameterize the voltage diagram by entering a number of parameters:

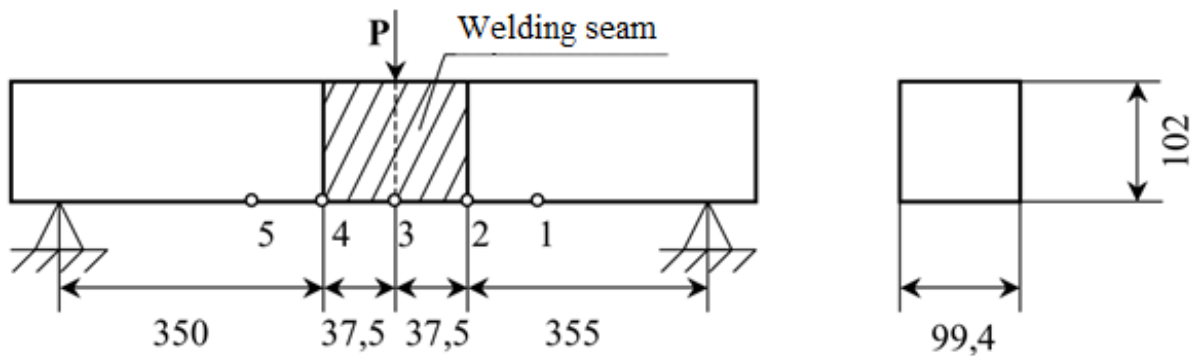
- $\sigma_{\Pi}$  - stresses on the surface, MPa;
- $\sigma_{\Pi\Pi 1}$  - maximum subsurface stresses I to the transition point of zero, MPa;

- $\sigma_{pp2}$  - maximum subsurface stresses 2 after the transition point of the sphere, MPa;
- $\sigma_m$  - voltage at the run-out of the plot, MPa;
- $h_0$  is the zero transition point of the stress diagram,  $\mu\text{m}$ .

These parameters quite fully reflect the nature of the stress state of the metal surface layer of the product [103,104].

Consider the use of SITON equipment in fatigue testing of beams with welded joints. The main type of tests was the cyclic effect on the sample on the test machine MUP-50 with periodic control of residual stresses by the non-destructive method of AFCH testing by SITON-ARM equipment.

The welded beam made of EN40 steel ( $\sigma_t = 390 \text{ MPa}$ ;  $\sigma_{av} = 550$  (650 MPa), the frequency of application of load (pulsation) 500 cycles / min was tested for fatigue bending. (Fig. 5.21). The geometric characteristics of the beam and the scheme of application of the load are given in Figure 5.22 in millimeters. The applied force  $p$  varied in the range (2-24) t.



*1 and 5 - outside the weld zone; 3 - welded seam; 2 and 4 - welding limit*

*Figure 5.22 - Scheme of the beam and types of measuring points*

During the tests in the areas of points (1... 5) indicated in Figure 4.11 (Figs. 5.22, 5.23), residual stresses were measured using SITON-workstation equipment every 100,000 load cycles (104,200, 1,897,000, 303,000, 397,000, 43,800).



Figure 5.23 - The sensor is installed in the area of the fourth point

According to the obtained plots of residual stresses, an analysis was performed, which showed the following results:

- the general nature of the distribution of residual stresses (plot) was maintained at all points (1,2,4,5) up to 303,000 load cycles (Fig. 5.24);

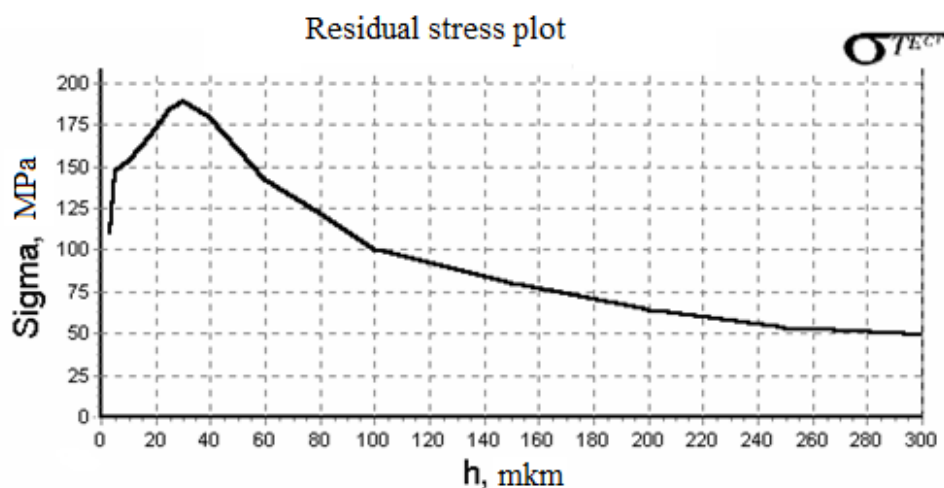


Figure 5.24 - Characteristic of oversized sponge up to 3000 cycles of delivery

- after 397,000 cycles of renewal in the area of point 2, the decrease in the level of surplus spills on a clay greater than 150 microns from 60 ... 75 to 25 ... 30 MPa was observed;
- after 397,000 cycles of renewal in the area of point 4, before the appearance of visible defects, an anomaly was detected in the surplus springs; relaxation of the tension was practically all over the pattern (Fig. 5.25); the sub-surface

stress changed from 180 to 125 MPa, at a depth of 200  $\mu\text{m}$  the change in the sign of a pressure of up to 50 MPa at a depth of 300  $\mu\text{m}$  was observed;

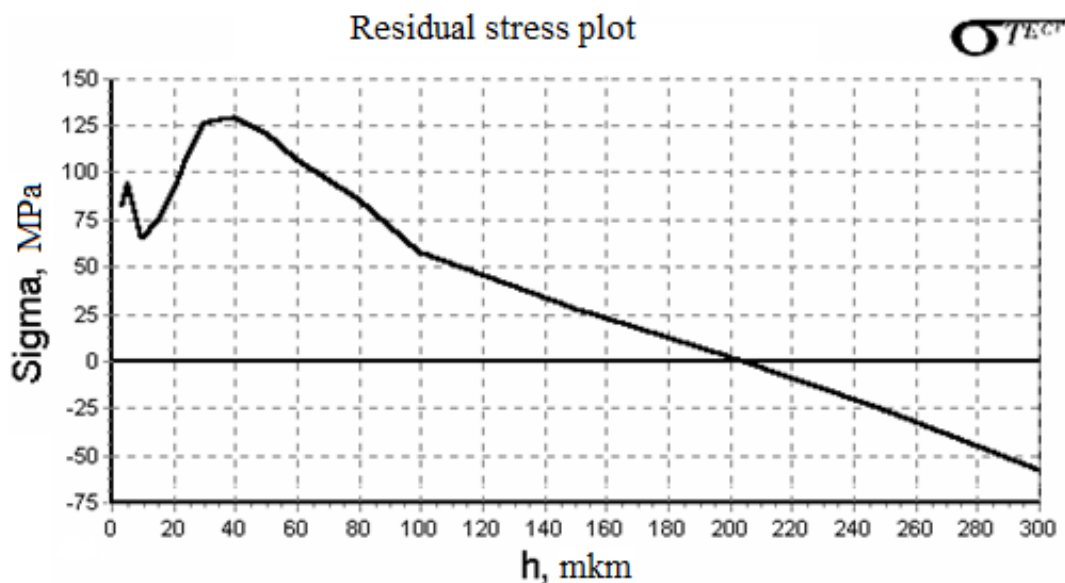


Figure 5.25 - Relaxation of surplus springs for 397000 cycles of delivery

- after 397000 cycles of renewal in the area of point 2, the decrease in the level of surplus spills on clay greater than 150 microns was observed, from 60 ... 75 to 25 ... 30 MPa; at 431,800 pulsations - the rupture of the beams to the outflow;

- after 397000 load cycles in the area of point 2 there was a marked decrease in the level of residual stresses at a depth of more than 150  $\mu\text{m}$ : from 60... 75 to 25... 30 MPa and subsequently, at 431800 pulsations - destruction of the beam - recorded residual stresses from 0 to 25 MPa;

- after 397000 load cycles in the area of point 4 before the appearance of visible defects there was a significant anomaly in the residual stress, a significant relaxation of stresses almost throughout the diagram (Fig. 5.25); subsurface stresses decreased from 180 to 125 MPa, at a depth of 200  $\mu\text{m}$  there is a change in the sign of stresses up to 50 MPa at a depth of 300  $\mu\text{m}$ ;

- the destruction of the beam occurred along the weld in the area of point 4 after 431,800 cycles, ie after 34,800 cycles after the detection of abnormal manifestations in the plot of residual stresses;

- after the destruction of the sample, the anomalous nature of the plot of residual stresses is preserved. The results of fatigue tests showed that the non-destructive method of AFCH testing, implemented in the equipment of SITON-ARM, allowed to predict the place and time of destruction of the sample. The limitation of the residual life of the sample during the tests was manifested after 400,000 cycles of loading due to the active relaxation of the plot of residual stresses for 34,800 cycles before failure. When measuring the residual stresses every 100,000 cycles of the load, the plot did not change, which indicated the integrity of the sample, confirmation of its resource characteristics and the possibility of continuing the tests until the next measurement.

## SECTION 6

### MAGNETIC RESONANCE PROCESSING OF MATERIALS

When considering materials, their fundamental properties are the most informative. Such properties include elasticity [26]. Any material object can be considered to some extent as an elastic system, which is characterized by well-defined types of natural oscillations with well-defined periods [27,28]. Real deformable bodies have an infinite number of degrees of freedom corresponding to all sorts of deformable states (bending, sliding, torsional, etc.), and therefore also an infinite number of shapes and frequencies of their own oscillations. Within a certain type of oscillations, in addition to the fundamental, lower resonant frequency, it is always possible to distinguish an infinite number of higher harmonic oscillations. However, of limited importance is the limited number of oscillations with a lower resonant frequency.

An approximate solution to the problem of natural oscillations of round plates was given in the last century [28]. Numerical methods using computers [30] obtained the exact values of the coefficients of proportionality, which relate linearly to the frequency of natural oscillations of a round plate with the speed of propagation of longitudinal elastic waves.

The modulus of elasticity is a mathematical description of the ability of bodies or substances to elastically deform when a force is applied to them. The modulus of elasticity (Young's modulus) characterizes the tensile / compressive resistance of a material to elastic deformation, or the property of an object to deform along an axis under the influence of force along this axis and is defined as the ratio of stress to elongation.

Widely known acoustic devices [29,31,32] for determining the modulus of elasticity, based on the measurement of the resonant oscillation frequency of the samples as a result of exposure to the sample of acoustic waves with a consistent change in their frequencies. The sample is installed between two piezoelectric elements (sensor and receiver) and gradually increase the frequency of the acoustic wave generator until the resonant frequency corresponding to the



natural oscillations of the sample is reached [29,32]. The signal from the receiver is observed on an oscilloscope and the maximum of this signal determines the resonant frequency. The obtained results are analyzed on the basis of ideas about the physical nature of the influence of the composition of alloys and their structure on the modulus of elasticity. However, this device uses manual smooth adjustment of the oscillation frequency, approximate determination of the maximum on the oscilloscope screen, manual processing of the experimental results and a significant amount of time for the experiment as a whole.

There is also a device for measuring the elastic characteristics of materials by acoustic action by measuring the resonant frequencies of the samples, based on providing tuning to the resonant frequency at the maximum amplitude by changing only the phase of oscillations [31]. This simplifies the method, but also does not preclude manual tuning to the resonant frequency and requires additional hardware, such as a feedback system and phase shifter.

Instruments and techniques developed to date, based on mechanical contact, allow measurements of the Young's modulus in a rather narrow range of absolute values [33]. This is due to both the design features of standard probes and the relative softness of the tip materials. At the same time, for objects where high rigidity is the main indicator of quality, measurement with existing instruments is not possible. The problem of determining the Young's modulus is especially acute in the study of multiphase structures, when there is a need to measure the elastic modulus of individual components, which differs from the value obtained by macroscopic measurements. In [33], a method for measuring the elastic modulus of Jung using a scanning probe microscope "Nanoscan" is proposed. The method allows to measure the Young's modulus on the scale of several hundred nanometers for a wide range of objects, including superhard materials. The method is based on measuring the dependence of the oscillation frequency of the probe in contact with the surface on the introduction of the needle tip into the surface under load.

All existing methods for determining the elastic properties of materials can be divided into static and dynamic [34]. Static methods are based on the experimental determination of the relationship between the load and the deformation of the sample, for example by stretching on a rupture machine. There are also methods for determining the elastic properties based on nanoindentation. Dynamic methods can be divided into transmission-wave and resonant. Transmission wave methods are based on measuring the speed of propagation of elastic waves in a sample, which is a function of the elastic properties and density of the material, and in the general case also the wave frequency (dispersion) and geometric parameters of the sample (geometric dispersion). There are pulsed resonance methods and resonant methods with continuous excitation. Resonance pulse methods are based on the excitation of oscillations of the sample by means of short-term (pulse) influence, which has a broadband amplitude-frequency spectrum, and registration of the sample response. Calculation of the response spectrum of the sample allows to identify the resonant frequencies of its oscillations. These frequencies depend on the geometric dimensions and shape of the sample, the boundary conditions, as well as the density and elastic properties of the material. As a rule, boundary conditions close to the free ones are used, and in this connection non-contact excitation and registration of oscillations are optimal, which allow to exclude the influence of the pathogen and the receiver on the oscillations of the sample. Resonant methods with continuous excitation are based on the excitation of oscillations of the sample by continuous exposure with a smoothly varying frequency and registration of the distribution of the amplitude of oscillations on the surface of the sample.

Many materials have high requirements for a set of performance properties - wear resistance, strength, heat resistance, viscosity, fracture [35,36,37]. One way to increase the efficiency of the tool is to strengthen the bulk heat treatment [38]. However, since heat treatment for maximum hardness and wear resistance leads to a decrease in the viscosity and crack resistance of

the cutting part of the tool, the problem of increasing the fracture toughness of the tool is relevant [39,40].

Existing methods of changing the physical and mechanical properties of materials on the working surface of products can be divided into five main classes [36]:

1) application to the surface of the thin-film layer: chemical deposition (oxidation, sulfidation, phosphating, application of reinforcing lubricant, deposition from the gas phase), electrolytic deposition (chromium plating, nickel plating, electrophoresis, nickel phosphating, boring, borochromium dehydration) vapors (Electrospark doping, thermal deposition of refractory compounds, cathodic-ion bombardment, direct electron beam evaporation, reactive electron beam evaporation, electrochemical evaporation), spraying of wear-resistant coatings (plasma spraying, spraying of electrospray materials).

2) the chemical composition of the surface layer, diffusion saturation (nitrooksidirovanie, nytrotsementatsyya, Karbonitratsiya, karbohromirovanie, nitriding, hromoazotirovanie, hromotitanirovanie, hromoalitirovanie, hromosilitsirovanie, borohromirovanie, boryrovanye, cyanidation, sulfotsianirovanie, diffusion plating, diffusion nickel, tsirkosilitsirovanie, borotsirkovanie, doping powerful beams ions);

3) change of structure of a surface layer: physical and thermal processing (laser hardening, plasma hardening), electrophysical processing (electropulse processing, electrocontact processing, electroerosive processing, ultrasonic processing), mechanical processing (vibration hardening, friction-strengthening) explosion, thermomechanical treatment, cross-wedge rolling, rolling, reduction), surfacing with alloy metal (surfacing with gas flame, electric arc, plasma, laser beam, ion beam);

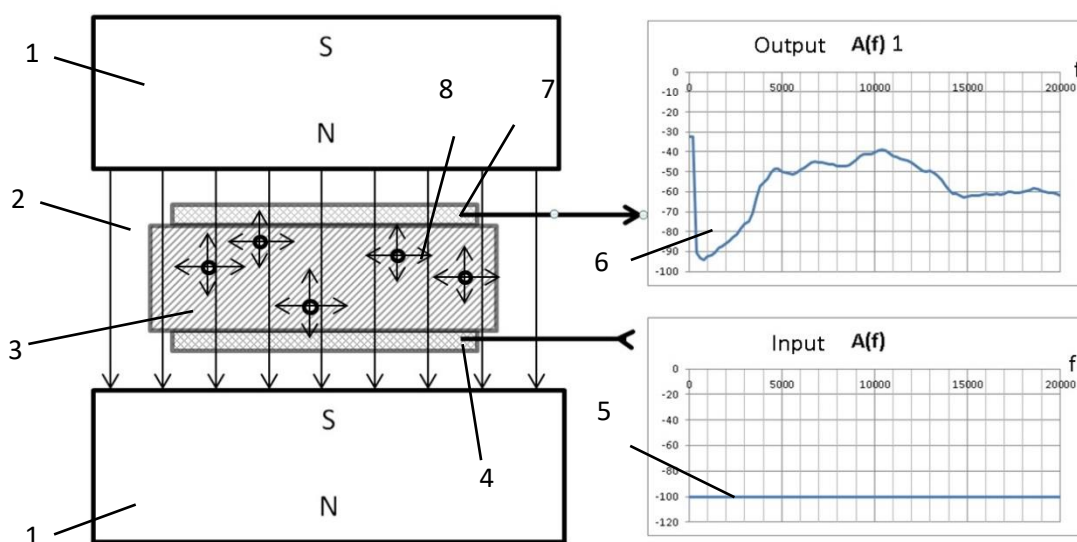
4) change in the energy reserve of the surface layer: treatment in a magnetic field (electroferromagnetic treatment, treatment in a pulsed magnetic field);

5) change of roughness of a surface layer: electrochemical polishing (immersion in a bath in a stream of electrolyte), processing by cutting (grinding, superfinishing, honing), plastic deformation (knurling, unrolling).

As for the change of physical and mechanical properties throughout the volume of the product, this can be achieved by changing the structure of the material throughout the volume of the product by heat treatment (hardening), cryogenic treatment (hardening followed by cold treatment).

The hardening processes of claims 1 to 5 are aimed at the material of a thin surface layer of the working part of the tool and are based either on direct contact, or use the effects of impulse of any nature, in which the effect acquires the properties of the skin effect [41]. Volumetric hardening during heat treatment has the effect that the uniform effect of heat flow on the entire volume of the tool material makes such volumetric processing and volumetric hardening possible. However, the uniformity of the heat flux requires time to equalize the temperature gradient in the volume of the material.

The paper shows the possibility of using as a uniform flux to influence the volume of the material of the magnetic field formed by powerful permanent magnets. The process of influencing the volume of the material of the experimental samples was that the effect of a uniform magnetic flux penetrating the sample is initiated by resonant oscillations of the sample caused by broadband exposure of equal amplitude using a "white noise" generator and a piezoelectric emitter. The schematic diagram of the installation is presented in Figure 6.1.



1 - neodymium magnets, 2 - uniform magnetic flux,

3 - experimental sample, 4 - piezoelectric emitter,  
 5 - frequency spectrum of the generator "white noise",  
 6 - frequency spectrum of natural oscillations of the sample in a magnetic field,  
 7 - piezoelectric sensor, 8 - activated elements of the experimental sample

Figure 6.1 - Schematic diagram of the experimental setup

The possibility of obtaining a positive effect of a positive change in the physical and mechanical properties of the material of the experimental samples is based on the following provisions.

It is known that the modulus of elasticity  $E$  and the density of the material of the sample  $\rho$  are associated with the resonant frequency  $f_0$  of the sample by the following dependence [42]:

$$f_0 = K_f \cdot \sqrt{\frac{E}{\rho}}, \quad (6.1)$$

where  $K_f$  – coefficient depending on the size of the sample.

In [43] it is noted that for cubic crystals, analogues of which are in the materials of hard alloys used in the production of cutting non-grinding plates are characterized by 3 types of elastic deformations and, accordingly, 3 independent elastic constants:

$$C_{\alpha\beta} = \frac{1}{V_0} \cdot \frac{\partial^2 E}{\partial \eta_\alpha \partial \eta_\beta} \Big|_{\eta=0},$$

where  $\alpha, \beta$  – indices showing the types of elastic deformations in the sample element;

$V_0$  – the volume of the sample element;

$\eta_\alpha, \eta_\beta$  – deformations in different directions of the Cartesian coordinate system.

Here it is necessary to take into account the three-dimensional nature of vibrations (deformations) in the resonance of each element of the volume of the material. Therefore, the detection of the effect of volume effect on the physical and mechanical properties of the experimental sample can be made on the basis of estimating the resonant frequency of the experimental sample and its change in the process of exposure to this sample. For this purpose, we used the

dependence proposed in [44]:

$$E = 1,64 \cdot m \cdot L^3 \cdot f^2 / d^4, \quad (6.2)$$

where  $m$  is the mass of the sample,  $L$  is the length of the sample,  $d$  is the diameter of the sample.

Based on these initial conditions, the determination of the resonant frequency of the experimental sample placed in a uniform magnetic field and subjected to resonant vibrations using a piezoelectric emitter and a piezoelectric sensor is based on the frequency spectrum of the sample in the magnetic field according to (6.3):

$$f_0 = \frac{\sum_{i=1}^n f_i \cdot A_{1i}(f_i)}{\sum_{i=1}^n A_i(f_{1i})}, \quad (6.3)$$
$$A_{1i} = A_i - A_{0i},$$

where  $A_{0i}$  – the amplitude of the  $i$ -th degree of the frequency spectrum of the hardware of the experimental stand in the absence of the excitation signal of the generator "white noise";

$A_i$  – the amplitude of the  $i$ -th degree of the frequency spectrum of the sample installed in the zone of uniform magnetic field of the experimental stand and excited by the signal of the generator "white noise" by means of a piezoelectric element that is part of the experimental stand;

$A_{1i}$  – intrinsic amplitudes of the  $i$ -th degree of the frequency spectrum of the sample placed in a uniform magnetic field.

The choice of piezoelectric elements as an emitter and sensor is due to the possibility of recording electric potentials during vibrations in a wide frequency range in the range of 10 Hz... 20 kHz. [45,46,47].

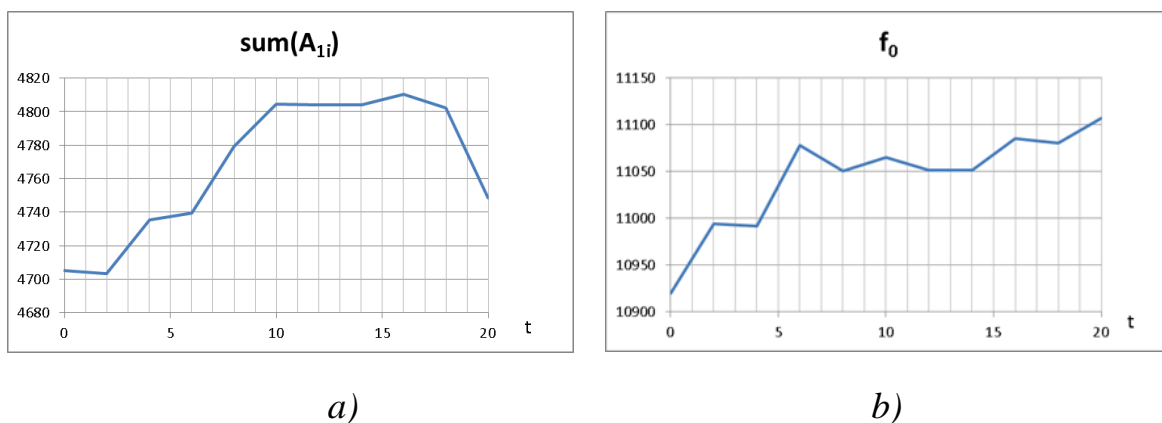
The results of experimental studies.

Testing of duralumin sample: before vibration treatment in a uniform magnetic field, the hardness of the sample with a diameter of 15 mm and a height of 8 mm is  $60 \div 80$  HB; after vibration treatment for 20 minutes the hardness of the sample was  $208 \div 212$  HB.

The increase in the sum of the individual sites of the amplitudes indicates that the sample becomes changing the viscosity of the material. This may indicate a

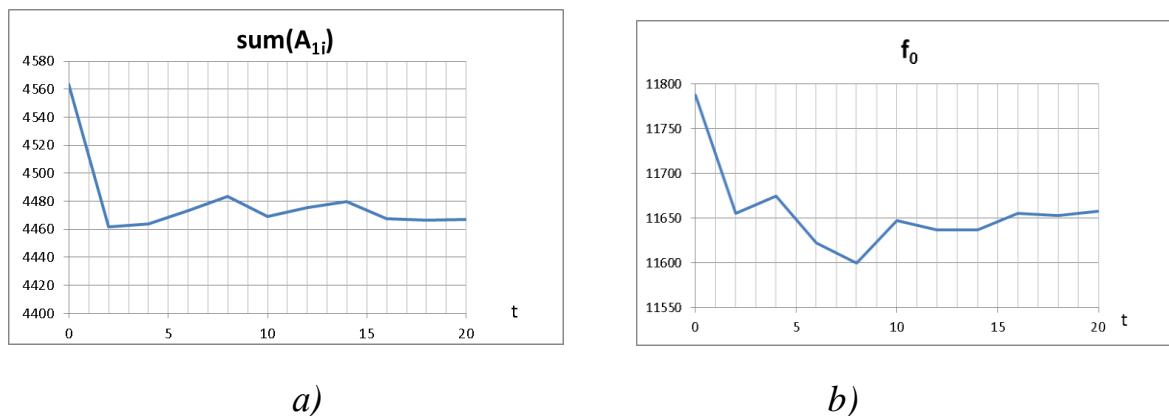
change in energy consumption for excitation of the sample. The increase in the resonant frequency can be explained by the increase in the modulus of elasticity of the material. All this leads to an increase in the hardness of the material. The increase in the resonant frequency, which indicates a change in the physical and mechanical properties are  $\Delta f_0 = 225$  Hz. Regression equations:

$$f_0 = 10922 + 36,23 \cdot t - 3,11 \cdot t^2 + 0,09 \cdot t^3.$$



$a - \sum_{i=1}^n A_i(f_{1i}); b - \text{resonant frequency } f_0$   
 Figure 6.2 – Change in the performance and resonant frequency of the duralumin sample during resonant vibration treatment lasting 20 minutes with a discreteness of 2 minutes

2. Copper sample test: before vibration treatment in a constant magnetic field, the hardness of the sample with a diameter of 20 mm and a height of 5 mm is  $60 \div 100$  HB; after vibration treatment for 20 minutes the hardness of the sample was  $220 \div 222$  HB. Regression equation:  $f_0 = 11770 - 44,45 \cdot t + 4,00 \cdot t^2 - 0,10 \cdot t^3$ .



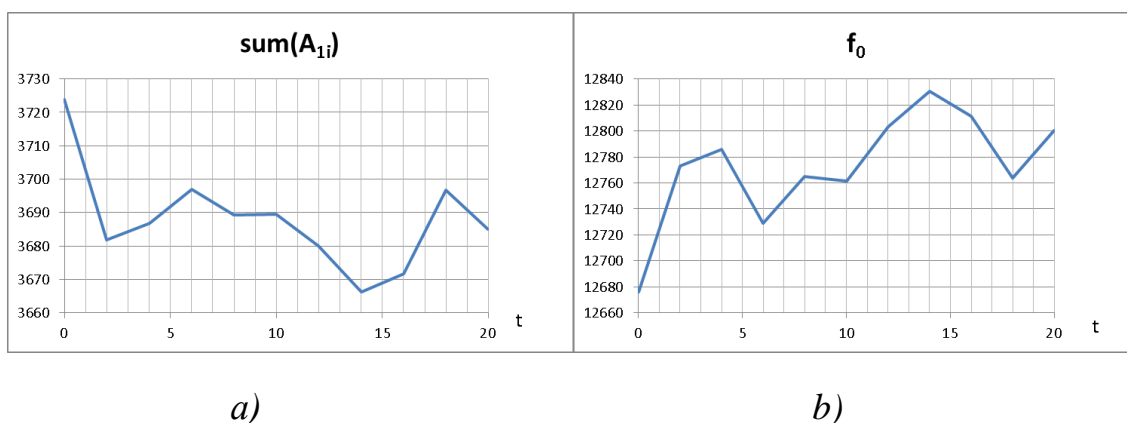
$$a - \sum_{i=1}^n A_i(f_{1i}); \quad b - \text{resonant frequency } f_0$$

Figure 6.3 – Change in indicators and resonant frequency of a copper sample at resonant vibration processing lasting 20 minutes with a discreteness of 2 minutes

A drop in the resonant frequency of the sample may indicate an increase in the density of the material, which leads to an increase in hardness. Simultaneous reduction of the integral characteristic of the frequency response of the natural oscillations of the sample also indicates an increase in energy consumption for resonant vibrations of the sample. The increase in the resonant frequency, which indicates a change in the physical and mechanical properties is  $\Delta f_0 = 150 \text{ Гц}$ .

3. Test of non-grinding plate of cutting tool made of hard alloy T15K6.

Regression equation:  $f_0 = 12706 + 13,58 \cdot t - 0,62 \cdot t^2 + 0,01 \cdot t^3$ .



$$a - \sum_{i=1}^n A_i(f_{1i}); \quad b - \text{resonant frequency } f_0$$

Figure 6.4 - Change in performance and resonant frequency of the sample T15K6 at resonant vibration processing lasting 20 minutes with a discreteness of 2 minutes

Increasing the resonant frequency of the sample ( $\Delta f_0 = 120 \text{ Hz}$ ) may indicate an increase in the modulus of elasticity of the material while increasing its viscosity. This is typical for polycarbonates, polyamides, composite materials.

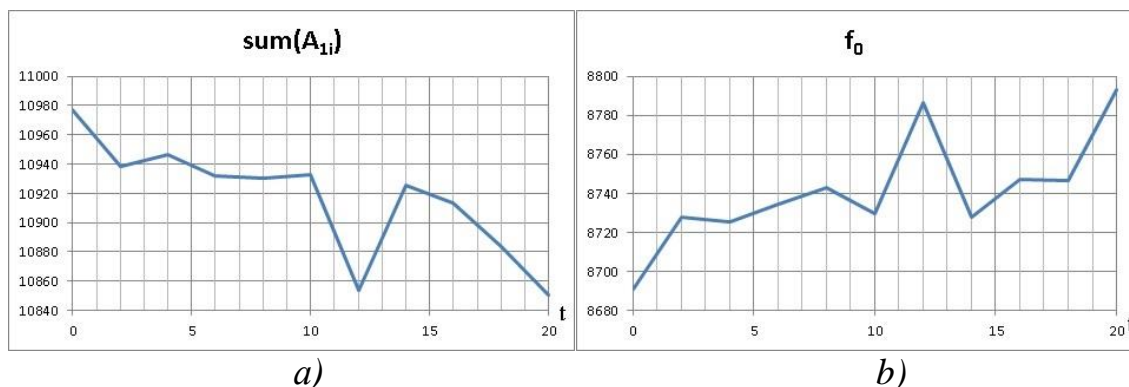
Testing of plates during turning of a batch of parts  $\varnothing 95.5 \text{ mm}$  made of 40X steel with a feed of  $0.5 \text{ mm / rpm}$  and a cutting speed of  $150 \text{ m / min}$  dimensional wear of T15K6 plates decreased by 40... 42%. This is an argument



in favor of vibration resonant processing of cutting inserts in a uniform magnetic field.

4. Testing of non-grinding plate of cutting tool made of hard alloy VK8.

Regression equation:  $f_0 = 8692.3 + 15.53 \cdot t - 1.53 \cdot t^2 + 0.05 \cdot t^3$ .



$$a - \sum_{i=1}^n A_i(f_{1i}); b - \text{resonant frequency } f_0$$

Figure 6.5 – Change in performance and resonant frequency of the sample VK8 at resonant vibration processing lasting 20 minutes with a discreteness of 2 minutes

Increasing the resonant frequency of the sample ( $\Delta f_0 = 70 \text{ Hz}$ ) may indicate an increase in the modulus of elasticity of the material while increasing its viscosity.

Testing of gray cast iron with cutters made of hard alloy VK8 with a hardness of 200... 220 HB when turning the sample with a cutting depth of 1.8 mm with a feed rate of 0.2 mm / rpm and a cutting speed of 114 m / min wear of plates with VK8 decreased by 32... 37%. It is shown that with increasing duration of such processing the increase in its efficiency decreases. In addition, the process of changing the properties of materials continues after vibration resonance treatment in a uniform magnetic field for the next 3... 5 days. The change of these properties is subject to exponential nature and for different materials has a different time constant. Then the indicators  $\sum_{i=1}^n A_i(f_{1i})$  i  $f_0$  stabilized, which indicates the cessation of the process of changing the properties of the material of the samples.

The results of processing in the magnetic field of other groups of samples of non-grinding cutting plates are presented in table 6.1.

*Table 6.1 - Hardness indices of non-grinding cutting plates before and after magnetic resonance processing in a uniform constant magnetic field*

Designation	Plate type	Plate number	Hardness during the experiment, HB		
			Before	After	$\Delta$ HB
CNMA 120408E-KD5,ACK15A		1	418	508	90
		2	427	508	81
		3	441	509	68
		4	443	512	69
		5	443	510	67
		6	445	508	63
WNMG 080408E-MC3 AP301M		7	431	488	57
		8	422	485	63
		9	431	488	57
		10	420	494	74
		11	424	481	57
		12	421	477	56
WNMG 080412E-PD3 AC250P		13	423	472	49
		14	432	469	37
		15	427	471	44
		16	428	480	52
		17	420	482	62
		18	413	476	63
SNGX 1206ANN-MM3 AP351U		19	419	517	98
		20	415	522	107
		21	419	510	91
		22	420	515	95
		23	423	508	85
		24	427	510	83
		25	423	511	88
		26	427	512	85
		27	415	513	98
		28	405	512	107

Such processing of non-grinding plates was accompanied by observations of the dynamics of change of indicators  $\sum_{i=1}^n A_i(f_{1i})$  i  $f_0$  presented in the table 6.2.

*Table 6.2 - Signatures of experimental samples*

Plate number	$\sum_{i=1}^n A_i(f_{1i})$	$f_0$
--------------	----------------------------	-------

1	2	3
1		
2, 3, 4		
5, 6		
7, 8		

Continuation of Table 6.2

1	2	3
9		
10, 11, 1 2		
1 3		
14, 1 5		
16, 17, 18		

An approximation of the change in performance before and after processing the plates in a magnetic field is given by the polynomials of the table 6.3

*Table 6.3 - Equation of approximation of test results*

Number of plates	Before processing	After processing
1	$y = -7E-06x^6 + 0,0009x^5 - 0,0449x^4 + 1,0646x^3 - 12,262x^2 + 61,835x - 8887,2$ $R^2 = 0,3295$	$y = -4E-06x^6 + 0,0005x^5 - 0,0274x^4 + 0,6685x^3 - 7,9931x^2 + 40,187x + 11320$ $R^2 = 0,1538$
2, 3, 4	$y = 7E-06x^6 - 0,0005x^5 + 0,006x^4 + 0,1811x^3 - 5,2342x^2 + 46,253x - 7465,4$ $R^2 = 0,883$	$y = 1E-06x^6 - 0,0002x^5 + 0,013x^4 - 0,3242x^3 + 4,5155x^2 - 35,046x + 11427$ $R^2 = 0,6571$
5, 6	$y = -2E-07x^6 + 4E-05x^5 - 0,0037x^4 + 0,1632x^3 - 3,5733x^2 + 38,345x - 7278,5$ $R^2 = 0,9018$	$y = 7E-08x^6 - 2E-05x^5 + 0,0022x^4 - 0,0988x^3 + 2,127x^2 - 21,064x + 11399$ $R^2 = 0,7988$
7, 8	$y = 7E-08x^6 - 2E-05x^5 + 0,0022x^4 - 0,0988x^3 + 2,127x^2 - 21,064x + 11399$ $R^2 = 0,7988$	$y = 2E-07x^6 - 3E-05x^5 + 0,0023x^4 - 0,0726x^3 + 0,9636x^2 - 3,4156x + 11084$ $R^2 = 0,6217$
9	$y = -6E-08x^6 + 2E-05x^5 - 0,0014x^4 + 0,0636x^3 - 1,4779x^2 + 16,075x - 6569,7$ $R^2 = 0,6803$	$y = 1E-07x^6 - 3E-05x^5 + 0,0027x^4 - 0,1058x^3 + 2,0336x^2 - 17,913x + 11317$ $R^2 = 0,6644$
10, 11, 12	$y = 2E-07x^6 - 4E-05x^5 + 0,003x^4 - 0,1171x^3 + 2,1844x^2 - 14,125x - 7216,8$ $R^2 = 0,8434$	$y = 2E-07x^6 - 5E-05x^5 + 0,0037x^4 - 0,1414x^3 + 2,5073x^2 - 16,142x + 11147$ $R^2 = 0,5984$
13	$y = -6E-09x^6 + 6E-07x^5 - 1E-06x^4 - 0,0013x^3 + 0,0241x^2 - 0,6317x - 7024,9$ $R^2 = 0,342$	$y = -5E-08x^6 + 7E-06x^5 - 0,0003x^4 + 0,0039x^3 + 0,1219x^2 - 3,9818x + 11845$ $R^2 = 0,2437$
14, 15	$y = -5E-08x^6 + 3E-05x^5 - 0,0035x^4 + 0,1787x^3 - 3,9025x^2 + 33,588x - 7265,2$ $R^2 = 0,9184$	$y = -4E-08x^6 + 3E-06x^5 + 0,0004x^4 - 0,0463x^3 + 1,6145x^2 - 14,363x + 10761$ $R^2 = 0,7982$
16, 17, 18	$y = 0,0001x^6 - 0,0083x^5 + 0,2479x^4 - 3,3883x^3 + 20,096x^2 - 35,008x - 6879,2$ $R^2 = 0,6093$	$y = 5E-05x^6 - 0,0038x^5 + 0,1058x^4 - 1,3926x^3 + 9,0349x^2 - 25,365x + 11024$ $R^2 = 0,4921$

The results of strengthening the non-grinding cutting inserts are shown in Figure 6.6.

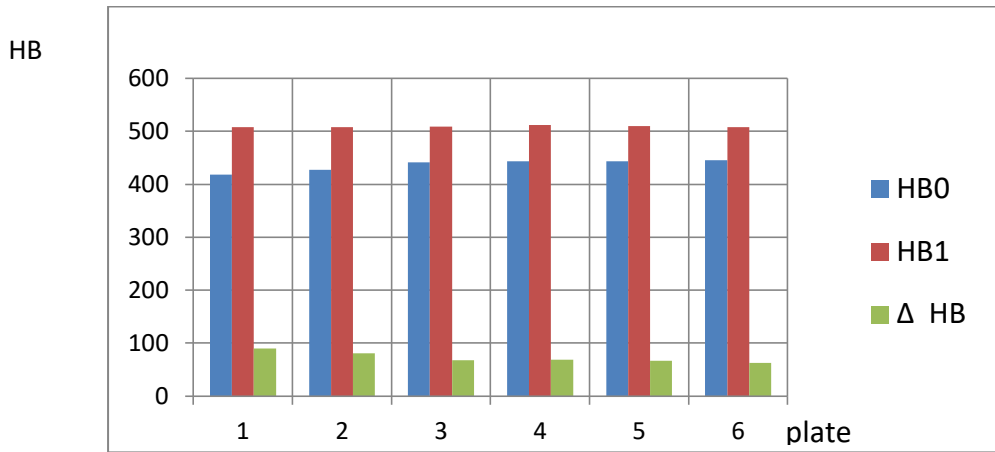


Figure 6.6 - The results of strengthening the non-grinding cutting inserts type CNMA 120408E-KD5

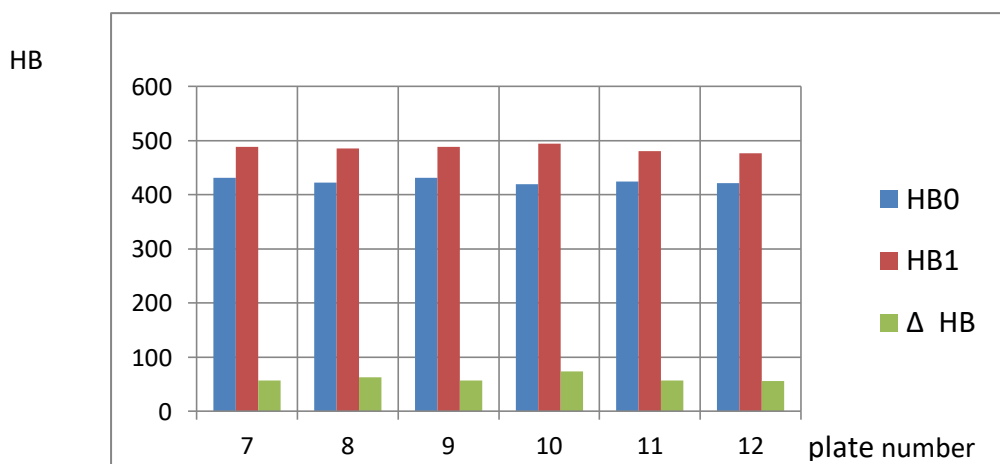


Figure 6.7 - The results of strengthening the non-grinding cutting inserts type WNMG 080408E-MC3 AP301M

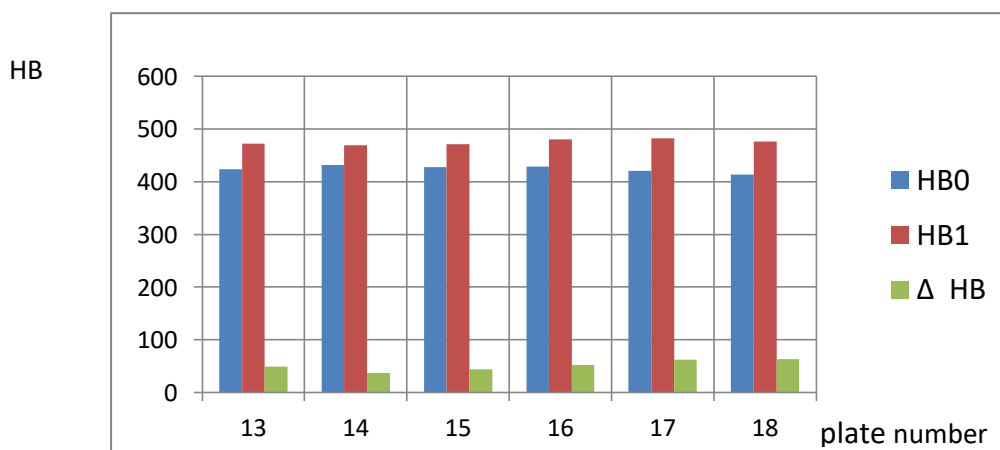


Figure 6.8 - The results of strengthening non-grinding cutting inserts type WNMG 080412E-PD3 AC250P

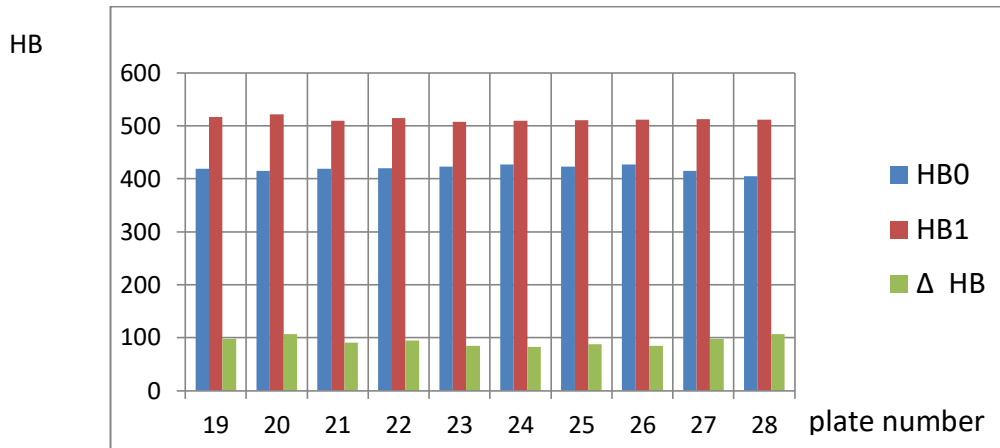


Figure 6.9 - Results of strengthening of non-grinding cutting plates of type SNGX 1206ANN-MM3 AP351U

Indicators of hardness and resonant frequencies of non-grinding cutting plates before and after magnetic resonance processing in a uniform constant magnetic field are given in the table 6.4.

Table 6.4 - The results of magnetic resonance imaging of the samples

Designation	Plate number	Before processing		After processing		Changes	
		Plate Hardness, HB	Resonance, Hz	Plate Hardness, HB	Resonance, f, Hz	Δ HB,	Δ f, Hz
CNMA 120408E-KD5,ACK 15A	1	418	11365	508	11235	90	130
	2	427	11403	508	11246	81	157
	3	441	11403	509	11278	68	125
	4	443	11403	512	11312	69	91
	5	443	11400	510	11339	67	61
	6	445	11400	508	11286	63	114
WNMG 080408E-MC3 AP301M	7	431	11092	488	11261	57	-169
	8	422	11092	485	11247	63	-155
	9	431	11291	488	11263	57	28
	10	420	11134	494	11262	74	-128
	11	424	11134	481	11262	57	-128
	12	421	11134	477	11249	56	-115
WNMG 080412E-PD3 AC250P	13	423	11835	472	11251	49	584
	14	432	10776	469	11246	37	-470
	15	427	10776	471	11247	44	-471
	16	428	11014	480	11239	52	-225
	17	420	11014	482	11234	62	-220

	18	413	11014	476	11222	63	-208
SNGX 1206ANN- MM3 AP351U	19	419	10785	517	11135	98	-350
	20	415	10957	522	11143	107	-186
	21	419	10655	510	11154	91	-499
	22	420	10694	515	11156	95	-462
	23	423	10849	508	11155	85	-306
	24	427	11249	510	11160	83	89
	25	423	11249	511	11155	88	94
	26	427	11249	512	11143	85	106
	27	415	11070	513	11159	98	-89
	28	405	11070	512	11159	107	-89

The increase in hardness is inversely proportional to the decrease in the resonant frequency of the cutting plate. For different types of cutting inserts, the correspondence of hardness to resonant frequencies is different and obviously depends on the design features. Therefore, on average, the change in resonant frequency is determined by the formula:  $\Delta HB = - (0,65 \dots 0,75) \cdot \Delta f_0$

For the plates of the most numerous group (SNGX 1206ANN-MM3 AP351U) the result is described by the formulas:

$$f_0 = -1,27 \cdot HB + 11802; \quad (6.4)$$

$$HB = -0,79 \cdot f_0 + 9317.$$

The generalized result can be described by dependence

$$f_0 = -1,53 \cdot HB + 11981; \quad (6.5)$$

$$HB = -0,66 \cdot f_0 + 7856.$$

Treatment of samples of materials placed in a uniform magnetic field, resonant polyfrequency vibrations with nano-dimensional amplitude in the range of 20... 80 nm. .

Conclusions:

Nanoscale amplitudes of natural oscillations of objects of complex shape in energy fields, which include uniform magnetic fields, can correct the physical



and mechanical properties of materials of such objects in order to achieve their identity or add strictly defined properties.

The study of this effect can be extended to a number of materials, their atomic-crystalline structures, ranges of magnetic fluxes, frequency ranges and estimates of the obtained physical and mechanical properties of the materials thus treated.

## SECTION 7

### MAGNETIC RESONANCE ACTIVATION STRENGTHENING TREATMENT

#### **7.1 Substantiation of the experimental method of research**

The problem in mechanical engineering is the wear of the friction surfaces of machine parts. The solution to this problem is the introduction of methods to increase the wear resistance of friction surfaces. Existing methods are time consuming, energy consuming, costly.

The purpose of the work is to improve the process to increase the wear resistance of friction surfaces. The solution to this problem is to activate the process of epilation, on work surfaces, using a rotating magnetic field at the stages of machining.

The paper hypothesizes that the application of activation to the chemical process of epilation in the form of a rotating magnetic field will strengthen and accelerate the hardening process, lead to the movement of grains, force them to order, there are conditions when grains become an obstacle to defects, energy absorption and change orientation of the magnetic moment relative to a constant field by introducing an excitation field of variable frequency.

#### **7.2 The method of the experiment**

*Objective:* to investigate the effect of activation of the epilation process by the action of a rotating magnetic field on the quality of friction surfaces of nodes.

*Objectives:* 1. to investigate the effect of a rotating magnetic field in combination with the epilation process on the wear resistance of friction surfaces.

2. Investigate the pattern of influence of the rotating magnetic field on the duration of processing, the frequency of the excitation field, the speed of rotation of

the part.

The object of research is an experimental sample in the form of a shaft with drilled necks.

Exciting action - a field of variable frequency.

The source of the excitatory action – pulse generator G5-54

Investigation of the effect of activation of epilation on a rotating magnetic field – based on the evaluation of hardness values measured by the ETM-01 hardness tester; wear - based on an assessment of photos taken by Mikroskop Kamera Conrad 1.3 Mio. Pixel, after friction.

### **7.3 Development and preparation of equipment for experimental research**

Stages of preparation for experimental research:

1st stage - making a tool to create a rotating magnetic field.

2nd stage - preparation of chemical epilating substance.

3rd stage - preparation and adjustment of the lathe 1k625.

4th stage - preparation of the experimental sample.

5th stage - preparation of the ETM-01 hardness tester for removal of hardness values, Mikroskop Kamera Conrad 1.3 Mio. Pixel for photo surface wear.

Stage 6 - installation of the experimental installation.

At the first stage, a tool was made to create a rotating magnetic field according to the electrical circuit shown in Figure 7.1.

The tool is a four magnetic conductors, the ends of which are brought together at one point, with coils that are offset by  $90^\circ$  relative to each other. The sinusoidal current in each of the four stationary coils produces four alternating magnetic fields perpendicular to the axis of rotation, which create one rotating magnetic field [68]. The motion of the 4-phase sinusoidal current in the windings L1, L2, L3 with a shift of  $\pi / 2$  is shown in Figure 7.1.

Number of turns  $N = 3500$  pieces on one coil, at length  $l = 43$  mm, outer diameter  $D = 10$  mm of the coil. Capacitance of one of the three connected capacitors  $C = 30\mu\text{F}$ .

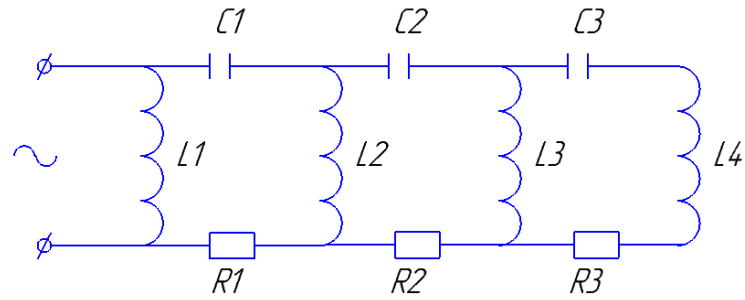


Figure 7.1 - Schematic diagram of a rotating magnetic field

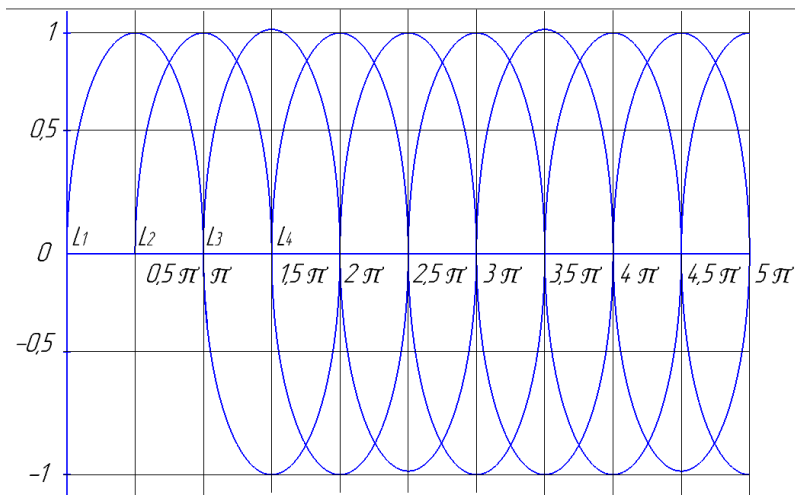


Figure 7.2 - Graph of current in windings  $L1, L2, L3, L4$

The calculation of the resonant frequency of the oscillating circuit is performed. Determination of the inductance of the coil was performed according to formula 7.1 [67]:

$$L = \frac{\left(\frac{D}{10}\right)^2 \cdot N^2}{(4,5 \cdot D) + (10 \cdot l)} \quad (7.1)$$

Hence, the inductance of the coil  $L = 25789 \mu\text{H}$ .

The frequency of the oscillating circuit is calculated by formula 7.2 [67]

$$f_{i=1\dots 4} = \frac{1}{2 \cdot \pi \cdot \sqrt{L_i \cdot C}} \quad (7.2)$$

Hence, the frequency  $f = 180$  Hz. For a perfect analysis, the study was performed at 100 Hz, 200 Hz, 300 Hz.

In the second stage, the chemical compound potassium fluoride KF was selected as the epilating solution, the properties of which are presented in Table 7.1. The main advantage when choosing this compound is its ability to exhibit diamagnetic properties, which are manifested in the magnetization of matter in the direction of the external magnetic field acting on it. The crystalline form of the solution for further use is diluted with distilled water, in a ratio that will lead to a transition to a liquid state.

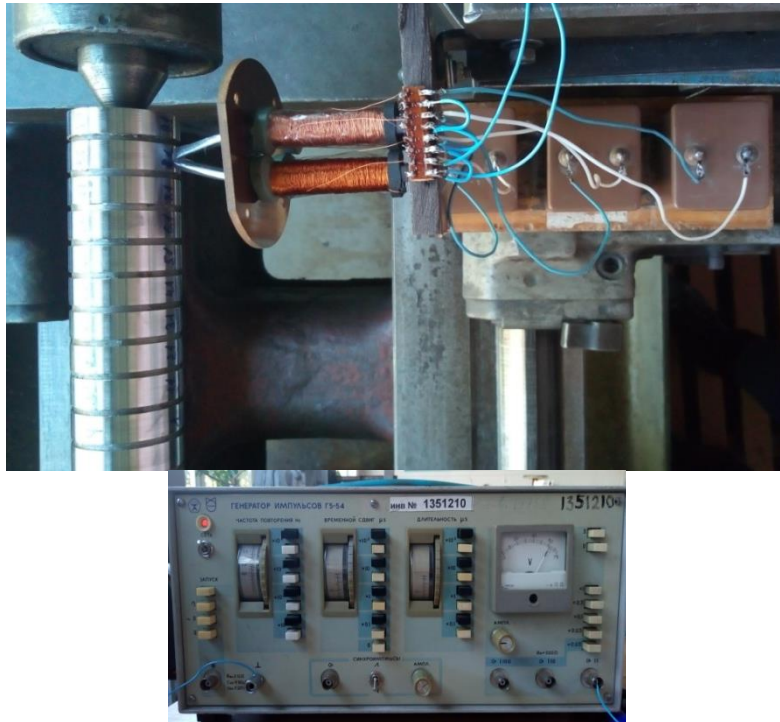
At the third and fourth stages, the lathe-screwdriver model 1k625 was adjusted, the workpiece was centered, turning and turning of the grooves for the formation of necks.

*Table 7.1 - Properties of the chemical compound "Potassium fluoride"*

Physical properties	
Molar mass	58,10 g / mol
The density	2,481 g / cm <sup>2</sup>
Thermal properties	
T. floating.	846 °C
T. kip.	1502 °C
Thermodynamic parameters	
Enthalpy of formation	-567,4 kJ / mol
Entropy of formation	66,6 J / (mol • K)
Enthalpy of melting	28,5 kJ / mol
The enthalpy of boiling	172,8 kJ / mol
Heat capacity	49,32 J / (mol • K)

In the fifth stage, the ETM-01 hardness tester was prepared for measurement to take hardness values, installed, connected to a computer and adjusted to high-quality mikroskop Kamera Conrad 1.3 Mio. Pixel for photo surface wear.

In the sixth stage, the installation is installed. A tool for creating a rotating magnetic field is installed in the tool holder. The source of voltage supply ( $U = 60V$ ) and frequency control in the experimental setup used a pulse generator G5-54 connected to the instrument. The experimental setup is shown in Figure 7.3.



*Figure 7.3 - Experimental setup*

### **Conducting experimental research**

1. Settings. Carry out tests of installation by means of the oscilloscope, to define a working range of parameters.

2. Processing and control. Consistently determine the hardness of all points of the sample to be processed. Carry out the processing of the experimental sample. Expose each of the 9 shaft necks at four points to a magnetic field for 2, 4, 6 minutes, at excitation frequency values of 100, 200, 300 Hz. Carry out the experiment presented in table 3.2, according to

randomization. Determine the hardness of each machined point. Determine the increase in hardness and the rate of formation of the increase in hardness.

3. Preparation of the sample. Remove the layer of material.

4. Processing and control. Treat for 20 minutes at each of the three points of one neck, pre-determine their initial hardness. Determine the hardness every 2 minutes of treatment with a rotating magnetic field.

5. Processing and control. Degrease and dry the experimental neck. Treat the neck with epilating KF solution diluted with water to a liquid state. Carry out the treatment lasting 20 minutes at each of the three points, pre-determine their initial hardness. Determine the hardness every 2 minutes of treatment with a rotating magnetic field.

6. Sample preparation. Remove the layer of material.

7. Processing and control. Carry out processing of necks, having preliminary defined their initial hardness, a rotating magnetic field at constant minimum possible giving of the tool, duration of influence of 4 minutes, frequency of 200 Hz, at speeds of rotation of a sample - 12,5, 16, 20 m / min. Carry out the experiment according to randomization according to table 3.3. Determine the hardness and hardness gain of each machined point.

8. Sample preparation. Remove the layer of material.

9. Processing and control. Degrease and dry the neck. Treat the neck with epilating KF solution. Carry out processing of necks, having preliminary defined their initial hardness, at the minimum giving of the tool, duration of influence of 4 minutes, frequency of 200 Hz, at speeds of rotation of a sample - 12,5, 16, 20 m / min. Carry out the experiment according to randomization according to table 3.3. Determine the hardness and hardness gain.

*Table 7.2 - Conducting the experiment according to randomization*

Neck	Point	Randomization	Time, min	Frequency, Hz
<i>1</i>	<i>2</i>	<i>3</i>	<i>4</i>	<i>5</i>

1	1.1	36	2	100
1	1.2	17	2	100
1	1.3	7	2	100
1	1.4	25	2	100
2	2.1	21	2	200
2	2.2	28	2	200
2	2.3	33	2	200
2	2.4	26	2	200
3	3.1	4	2	300
3	3.2	19	2	300
3	3.3	32	2	300
3	3.4	29	2	300
4	4.1	8	4	100
4	4.2	6	4	100
4	4.3	35	4	100
4	4.4	31	4	100
5	5.1	2	4	200
5	5.2	13	4	200
5	5.3	27	4	200
5	5.4	34	4	200
6	6.1	20	4	300
6	6.2	5	4	300
6	6.3	14	4	300
6	6.4	9	4	300
7	7.1	15	6	100
7	7.2	22	6	100
7	7.3	16	6	100
7	7.4	1	6	100
8	8.1	12	6	200
8	8.2	30	6	200
8	8.3	11	6	200
8	8.4	18	6	200
9	9.1	23	6	300
9	9.2	10	6	300
9	9.3	3	6	300
9	9.4	24	6	300

*Table 7.3 - Conducting an experiment with a change in speed according to with randomization*

$V_{det}$ , m / min	Number	Randomization
	1.1	7



12,5	1.2	13
	1.3	18
	2.1	21
	2.2	2
	2.3	25
	3.1	5
	3.2	14
	3.3	27
16,0	4.1	1
	4.2	6
	4.3	9
	5.1	20
	5.2	11
	5.3	22
	6.1	3
	6.2	12
	6.3	8
20,0	7.1	24
	7.2	23
	7.3	15
	8.1	4
	8.2	17
	8.3	26
	9.1	16
	9.2	19
	9.3	10

1. Determine the width of wear at the duration of the test tool 3, 6, 8 minutes at the same force and speed of rotation of the sample.

### **Analysis of the results of experimental research**

As a result of conducting an experiment with time and frequency variables, the results of measuring hardness, value of growth and growth rate were obtained (Table 7.4).

Table 7.4 - The results of the experiment with time and frequency variables

Point	Hardness , HB		Increase, HB	Increase <sub>sr</sub> , HB	Speed, HB/ min	Speed <sub>sr</sub> , HB/ min
	HB <sub>0</sub>	HB <sub>1</sub>				
<i>I</i>	<i>2</i>	<i>3</i>	<i>4</i>	<i>5</i>	<i>6</i>	<i>7</i>
1.1	230,3	236,0	5,7		2,6	

1.2	230,3	234,9	4,6	6	2,3	2,3
1.3	224,7	231,5	6,8		2,0	
1.4	221,2	228,1	6,9		2,0	
2.1	239,4	245,1	5,7	5,4	2,9	2,7
2.2	228,1	233,8	5,7		2,9	
2.3	232,6	237,2	4,6		2,3	
2.4	232,6	258,3	5,7		2,9	
3.1	234,9	242,9	8,0	8,6	2,2	2,4
3.2	220,1	228,1	8,0		2,2	
3.3	217,8	226,9	9,1		2,6	
3.4	230,3	239,4	9,1		2,6	
4.1	228,1	236,0	7,9	9,1	2,0	2,3
4.2	231,5	240,6	9,1		2,3	
4.3	236,0	246,3	10,3		2,6	
4.4	233,8	242,9	9,1		2,3	
5.1	232,6	241,7	9,1	9,4	4,3	4,3
5.2	226,9	237,2	10,3		4,6	
5.3	233,8	242,9	9,1		4,3	
5.4	226,9	236,0	9,1		4,3	
6.1	223,5	234,9	11,4	10,8	2,9	3,3
6.2	219,0	230,3	11,3		3,6	
6.3	232,6	242,9	10,3		3,1	
6.4	231,5	241,7	10,2	10,8	3,4	3,3
7.1	216,7	226,9	10,2	11,9	1,7	2,0
7.2	222,4	236,0	13,6		2,3	
7.3	232,6	245,1	12,5		2,1	
7.4	234,9	246,3	11,4		1,9	
8.1	217,8	231,5	13,7	14,5	2,3	2,4
8.2	213,3	228,1	14,8		2,5	
8.3	225,8	238,3	12,5		2,1	
8.4	217,8	234,9	17,1		2,9	
9.1	215,6	230,3	14,7	14,2	2,5	2,4
9.2	212,1	226,9	14,8		2,5	
9.3	221,2	234,9	13,7		2,3	
9.4	220,1	233,8	13,7		2,3	

Based on the obtained data, graphs of dependence were constructed: hardness on time (Fig. 7.4), hardness on the excitation frequency (Fig. 7.5), hardness growth rate on the processing parameters (Fig. 7.6).

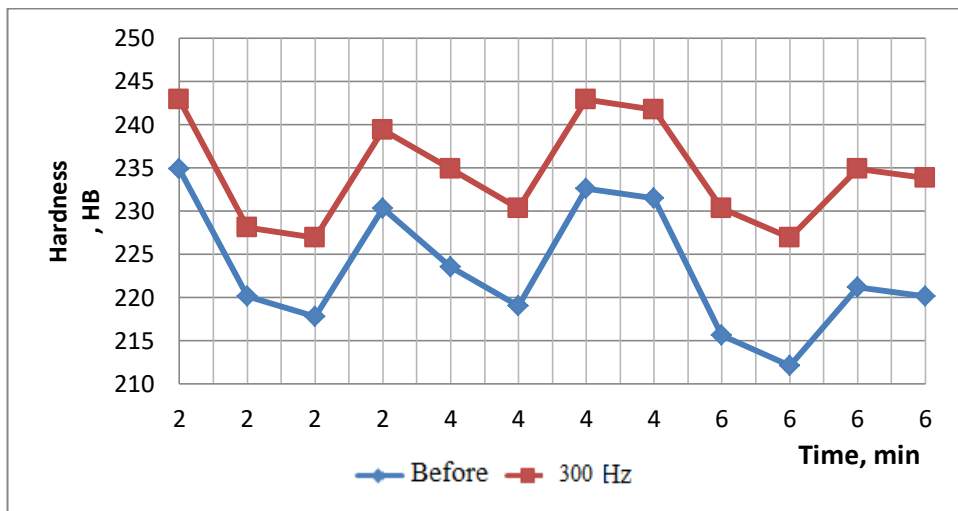
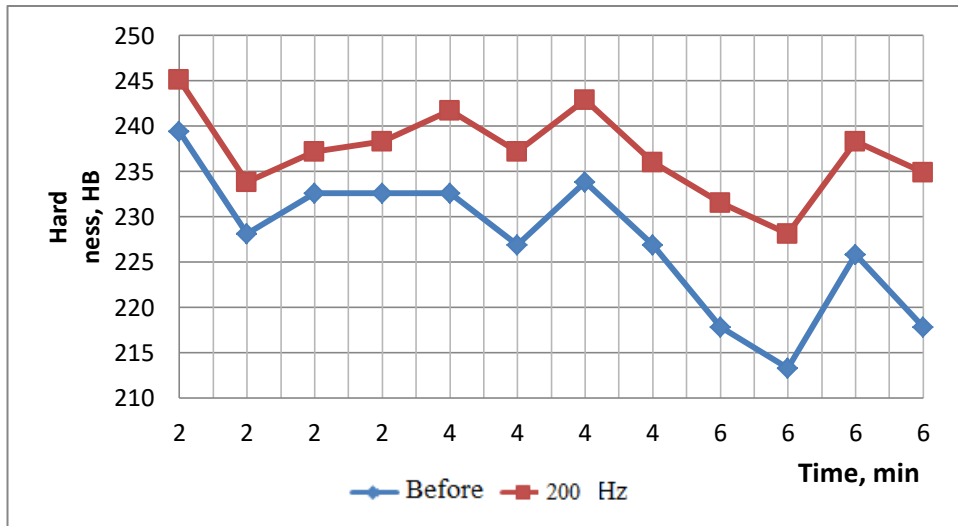
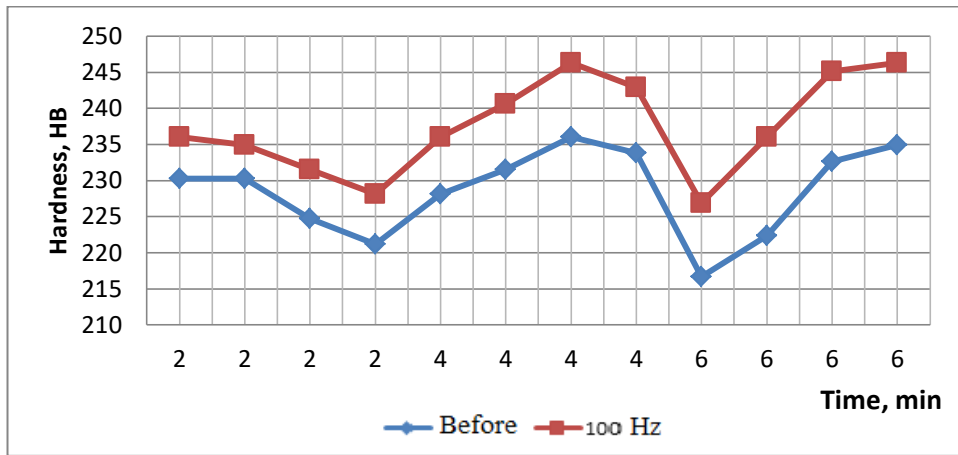


Figure 7.4 - Graphs of hardness versus processing time

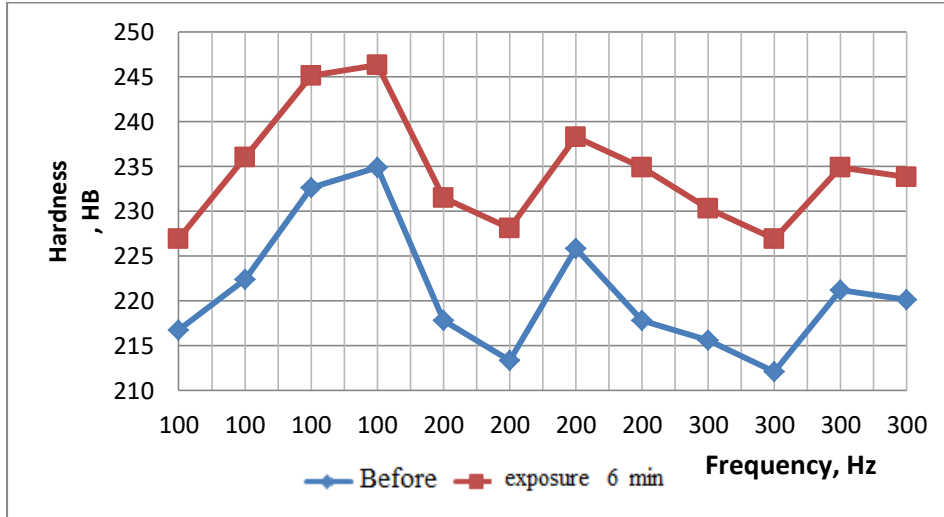
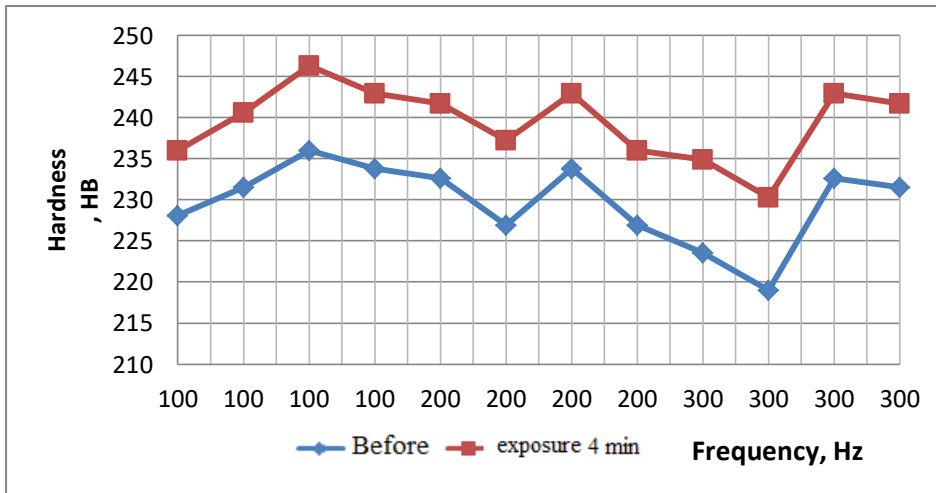
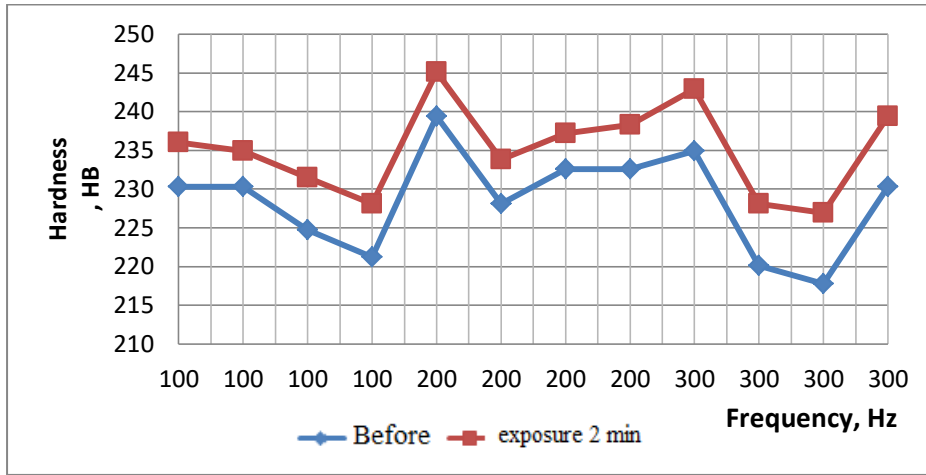


Figure 7.5 - Graphs of hardness from the excitation frequency

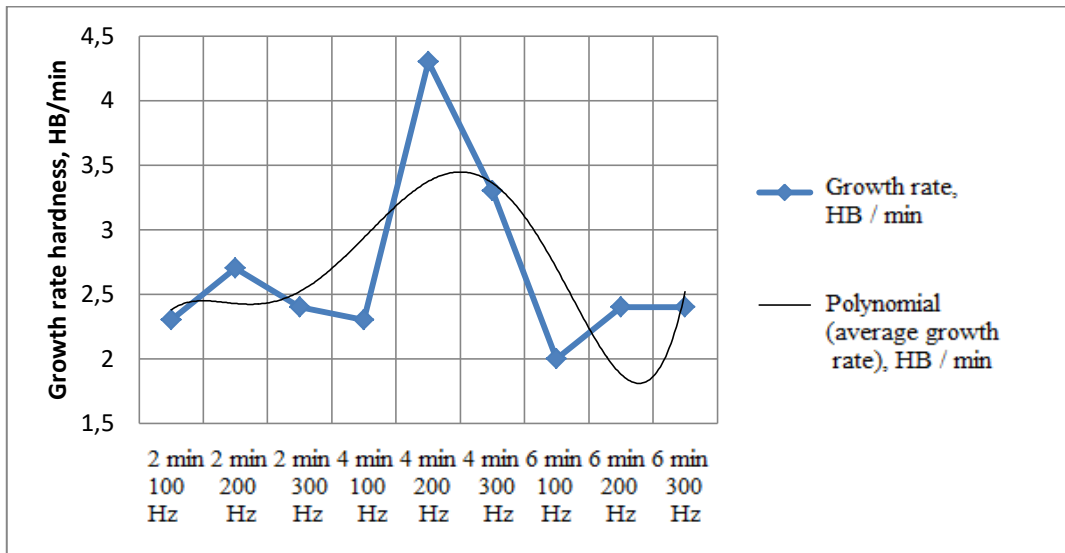


Figure 7.6 - Graph of the rate of hardness growth from processing parameters

As a result of the experiment of the point effect of a rotating magnetic field and the effect of epilation and activation by a rotating magnetic field for 20 minutes (hardness measurement interval 2 minutes), the results were obtained (Table 7.5).

Table 7.5 - The results of the experiment of treatment by rotating magnetic field (OMP) and epilation with activation (OMP + surfactant).

Time, min	Hardness after WMD, HB				Hardness after WMD + surfactants, HB			
	Point			HB <sub>sr</sub>	Point			HB <sub>sr</sub>
	1	2	3		1	2	3	
0	237,2	234,9	234,0	235,4	238,3	236,0	234,9	236,4
2	242,9	248,5	246,3	245,9	254,2	251,9	249,7	251,9
4	249,7	258,7	253,1	253,8	271,1	266,6	267,7	268,5
6	262,1	264,4	263,2	263,2	272,2	268,9	270,0	270,4
8	268,9	267,7	268,9	268,5	259,8	254,2	256,5	256,8
10	254,2	261,0	259,8	258,3	262,1	253,1	257,6	257,6
12	263,2	258,7	257,6	259,8	261,0	257,6	259,8	259,5
14	261,0	250,8	256,6	256,1	257,6	259,8	261,0	259,5
16	259,8	254,2	258,7	257,6	262,1	262,1	258,7	261,0
18	258,7	255,3	256,5	256,8	263,1	257,6	261,0	260,6
20	258,7	254,2	255,3	256,1	264,4	261,0	262,1	262,5

Based on the obtained data, a graph (Fig. 7.7) of the dependence of hardness on the exposure time and processing method is constructed.

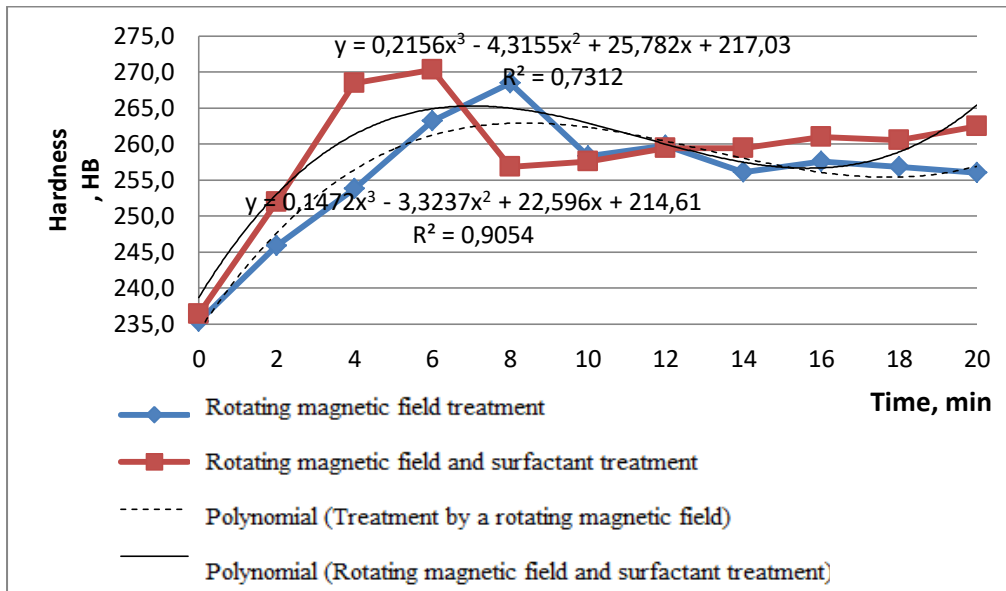


Figure 7.7 - Graph of the dependence of hardness on the duration of processing with a different method of strengthening

As a result of processing by a rotating magnetic field at different speeds of rotation of the part, the experimental data were obtained (Table 7.6), on the basis of which a graph of the dependence of the obtained hardness values was constructed (Fig. 7.8).

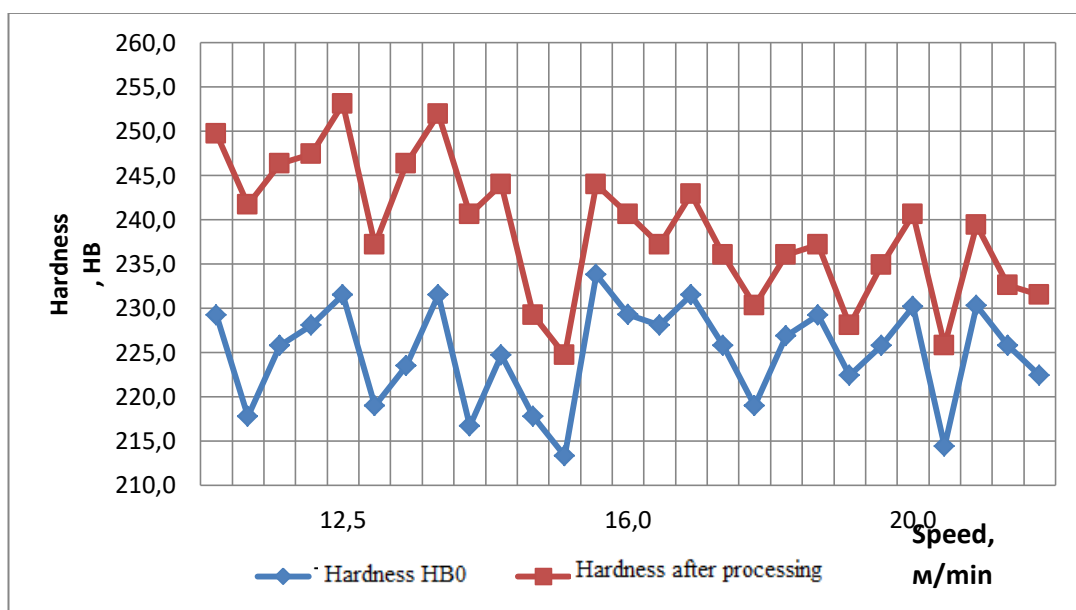
Table 7.6 - The results of the experiment of treatment with a rotating magnetic field at different speeds of rotation of the sample

Vdet, m / min	Number	Hardness <sub>0</sub> , HB	Hardness <sub>1</sub> , HB	Increase, HB
<i>I</i>	<i>2</i>	<i>3</i>	<i>4</i>	<i>5</i>
12,5	1.1	229,2	249,7	20,5
	1.2	217,8	241,7	23,9
	1.3	225,8	246,3	20,5
	2.1	228,1	247,4	19,3
	2.2	231,5	253,1	21,6
	2.3	219,0	237,2	18,2
	3.1	223,5	246,3	22,8
	3.2	231,5	251,9	20,4
	3.3	216,7	240,6	23,9

Continuation of Table 7.6

<i>I</i>	<i>2</i>	<i>3</i>	<i>4</i>	<i>5</i>
Average value				21,2
16	4.1	224,7	244,0	19,3

	4.2	217,8	229,2	11,4
	4.3	213,3	224,7	11,4
	5.1	233,8	244,0	10,2
	5.2	229,3	240,6	11,3
	5.3	228,1	237,2	9,1
	6.1	231,5	242,9	11,4
	6.2	225,8	236,0	10,2
	6.3	219,0	230,3	11,3
Average value				11,7
20,0	7.1	226,9	236,0	9,1
	7.2	229,2	237,2	8,0
	7.3	222,4	228,1	5,7
	8.1	225,8	234,9	9,1
	8.2	230,2	240,6	10,4
	8.3	214,4	225,8	11,4
	9.1	230,3	239,4	9,1
	9.2	225,8	232,6	6,8
	9.3	222,4	231,5	9,1
Average value				8,7



*Figure 7.8 - Graph of the dependence of hardness on velocity when processed by a rotating magnetic field*

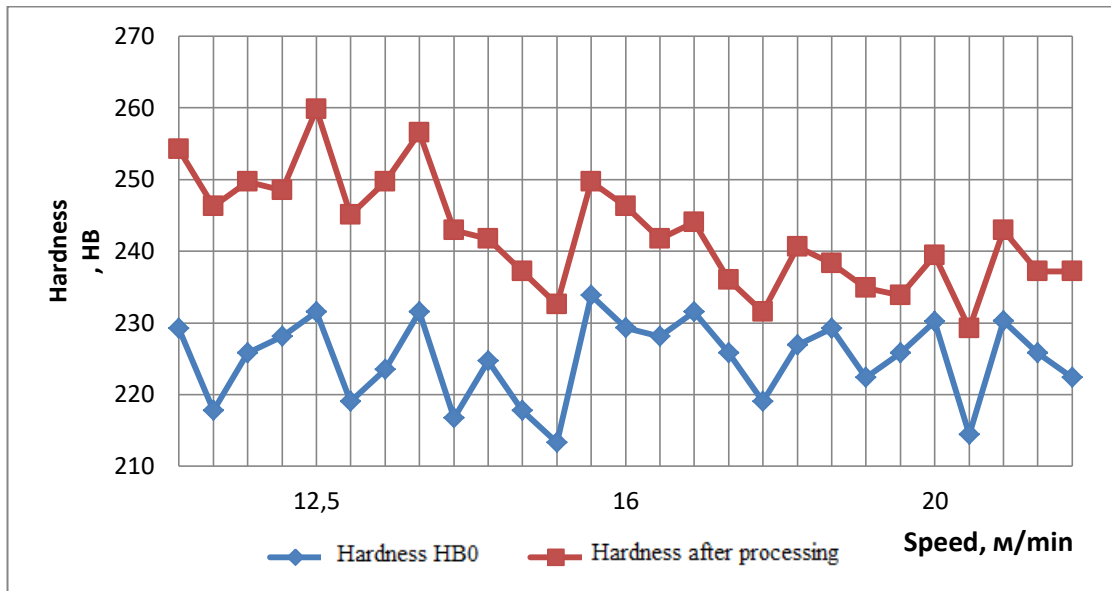
As a result of processing the sample with epilating solution and its activation by a rotating magnetic field, at different speeds of rotation of the part,

the experimental data were obtained (Table 7.7), on the basis of which a graph of the obtained hardness values was constructed (Fig. 7.9).

*Table 7.7 - The results of the experiment of treatment by epilation and activation by a rotating magnetic field at different speeds*

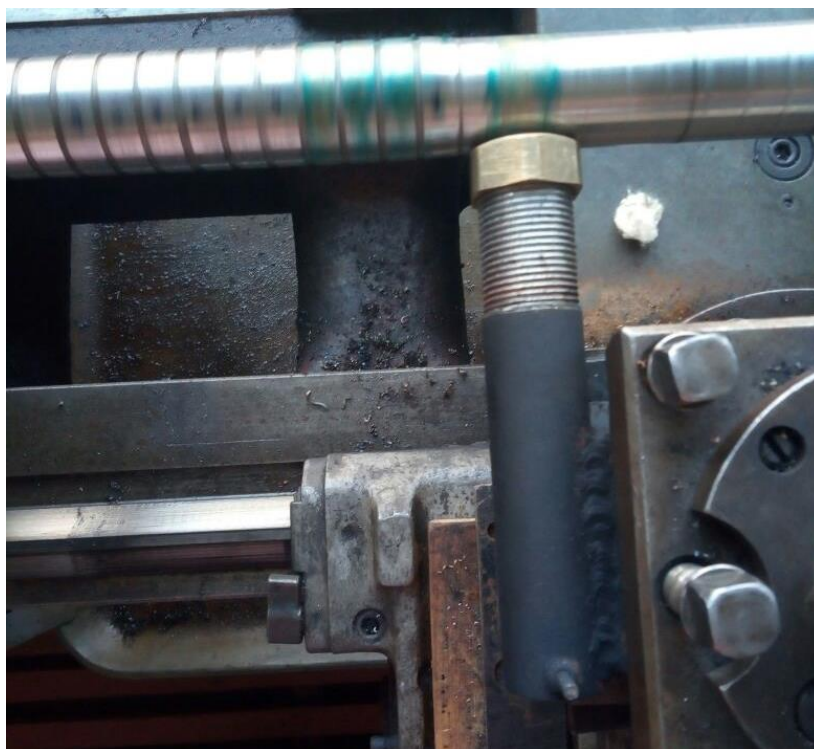
Vdet, m / min	Number	Hardness0, HB	Hardness1, HB	Increase, HB
12,5	1.1	229,2	254,2	25,0
	1.2	217,8	246,3	28,5
	1.3	225,8	249,7	23,9
	2.1	228,1	248,5	20,4
	2.2	231,5	259,8	28,3
	2.3	219,0	245,1	26,1
	3.1	223,5	249,7	26,2
	3.2	231,5	256,5	25,0
	3.3	216,7	242,9	26,2
Average value				25,5
16	4.1	224,7	241,7	17,0
	4.2	217,8	237,2	19,4
	4.3	213,3	232,6	19,3
	5.1	233,8	249,7	15,9
	5.2	229,3	246,3	17,0
	5.3	228,1	241,7	13,6
	6.1	231,5	244,0	12,5
	6.2	225,8	236,0	10,2
	6.3	219,0	231,5	12,5
Average value				15,3
20	7.1	226,9	240,6	13,7
	7.2	229,2	238,3	9,1
	7.3	222,4	234,9	12,5
	8.1	225,8	233,8	8,0
	8.2	230,2	239,4	9,2
	8.3	214,4	229,2	14,8
	9.1	230,3	242,9	12,6
	9.2	225,8	237,2	11,4
	9.3	222,4	237,2	14,8
Average value				11,8





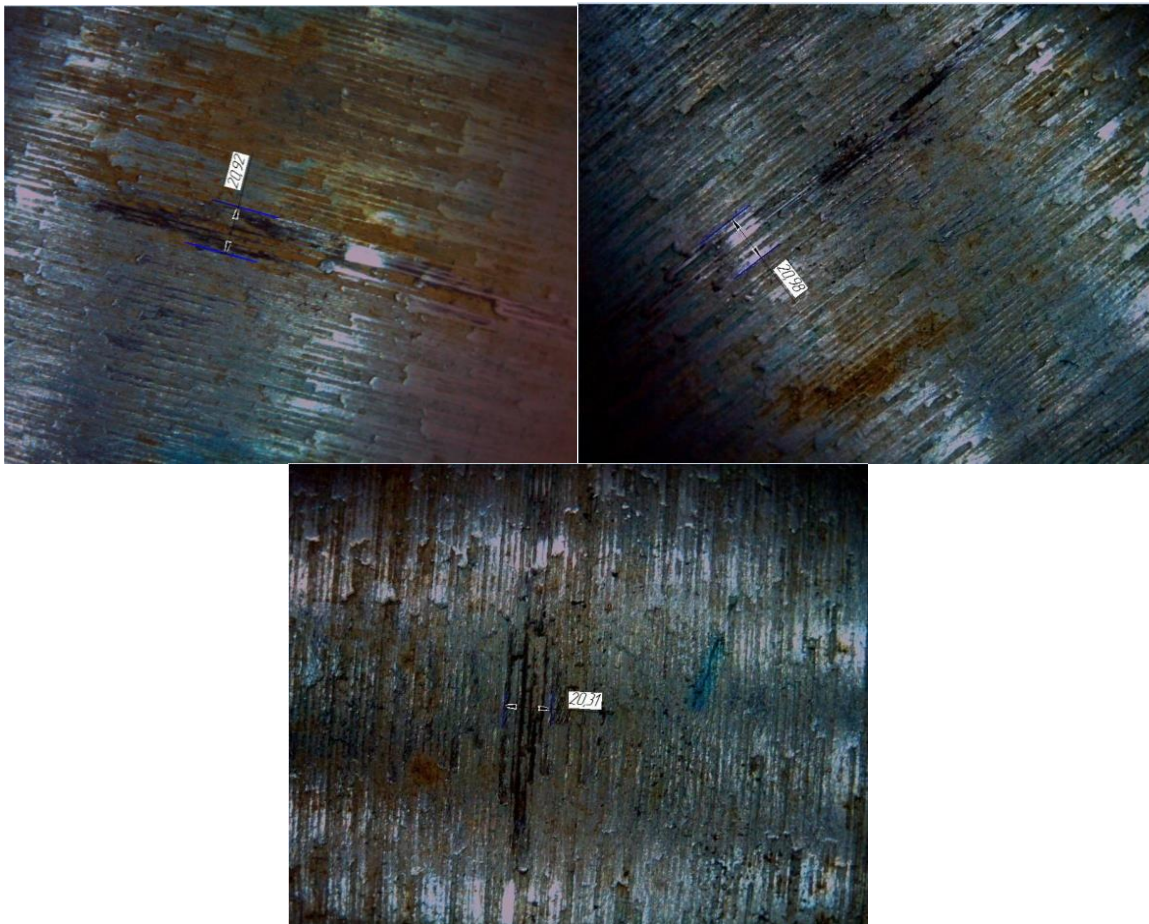
*Figure 7.9 - Graph of the dependence of hardness on velocity during processing by epilation and activation by a rotating magnetic field*

An experiment was performed, the installation of which is shown in Figure 7.10, which is related to the sample for its wear resistance using a test tool.

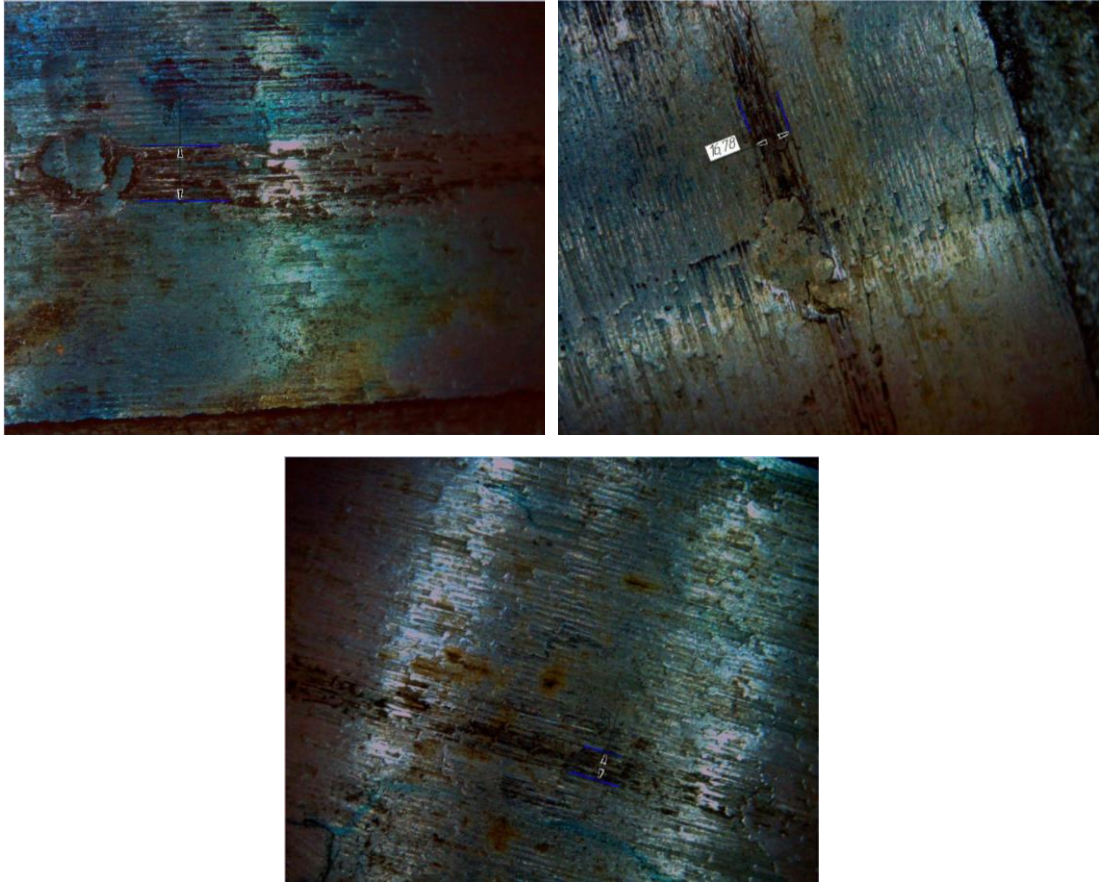


*Figure 7.10 - Test setup*

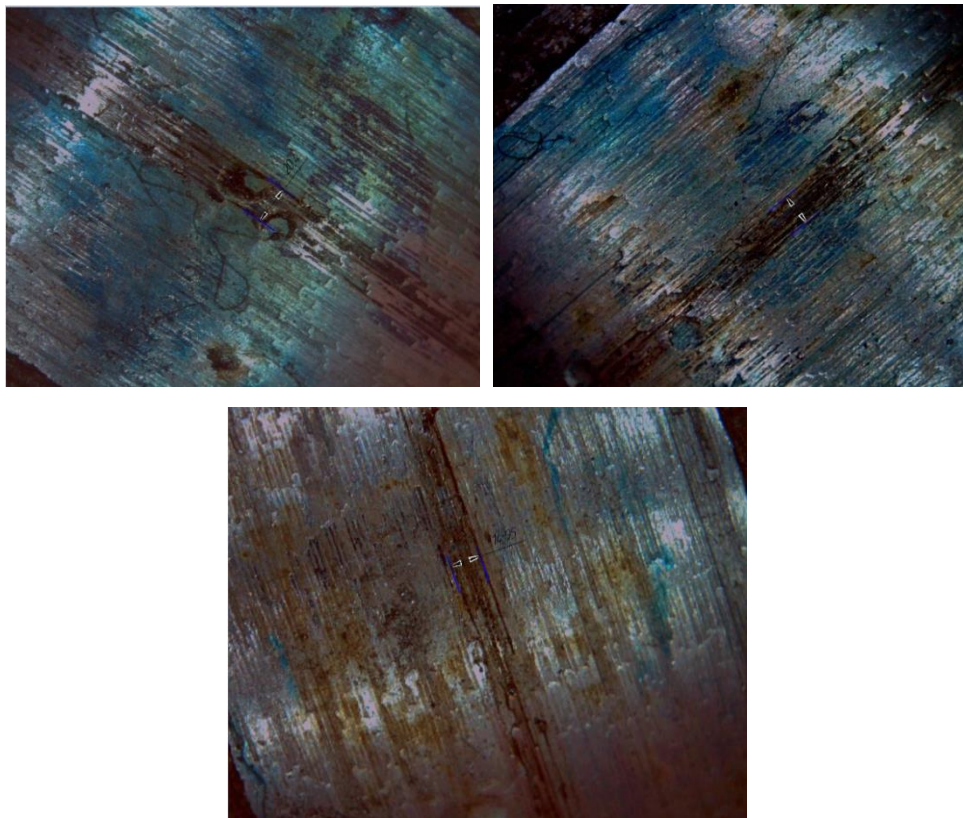
The tool is installed in the tool holder, adjusted to the same force of impact on the sample throughout the experiment, the sample is given a constant speed. The study was performed on four necks of the sample, one of which was not treated, and the other three were treated by epilation and activation by a rotating magnetic field for 4 minutes and a frequency of 200 Hz. Wear resistance was determined by the results presented in table 7.8, the width of the track after the test, based on the photos taken in Figures 7.11... 7.22, using a camera. The graph given in Figure 7.23, the dependence of the track width on the duration of the test.



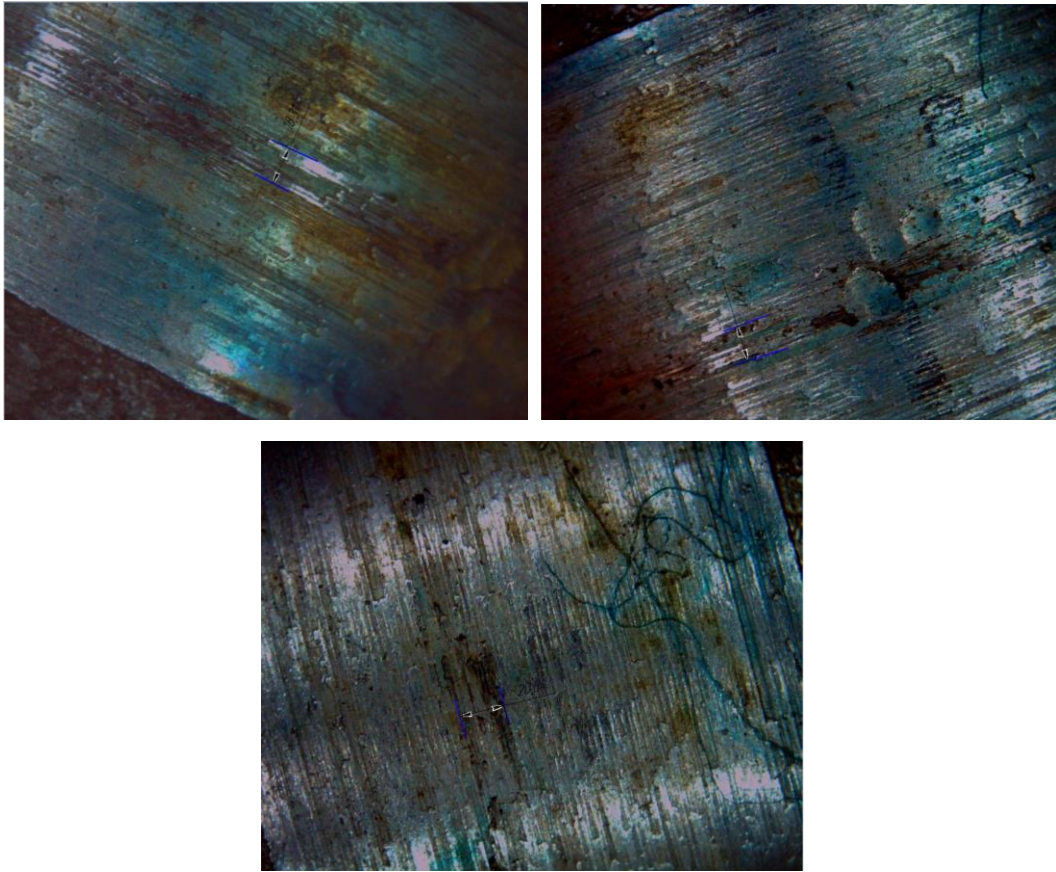
*Figure 7.11 - Raw sample after 3 minutes of testing*



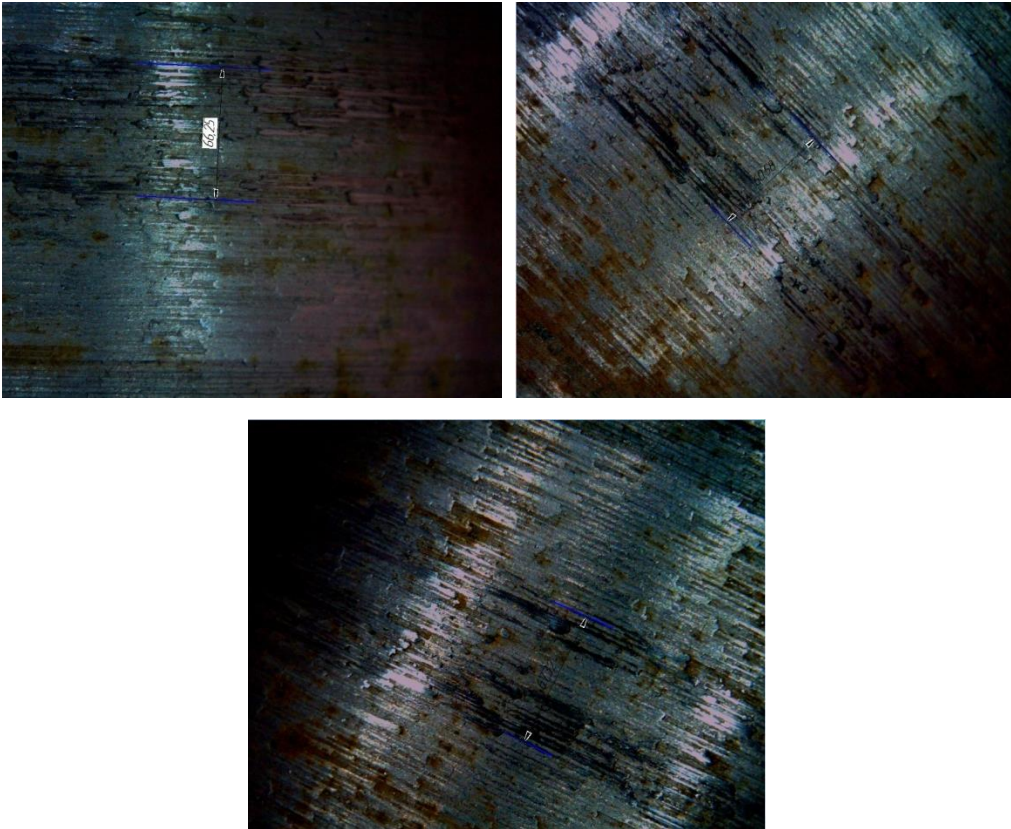
*Figure 7.12 - Treated the first neck after 3 minutes of testing*



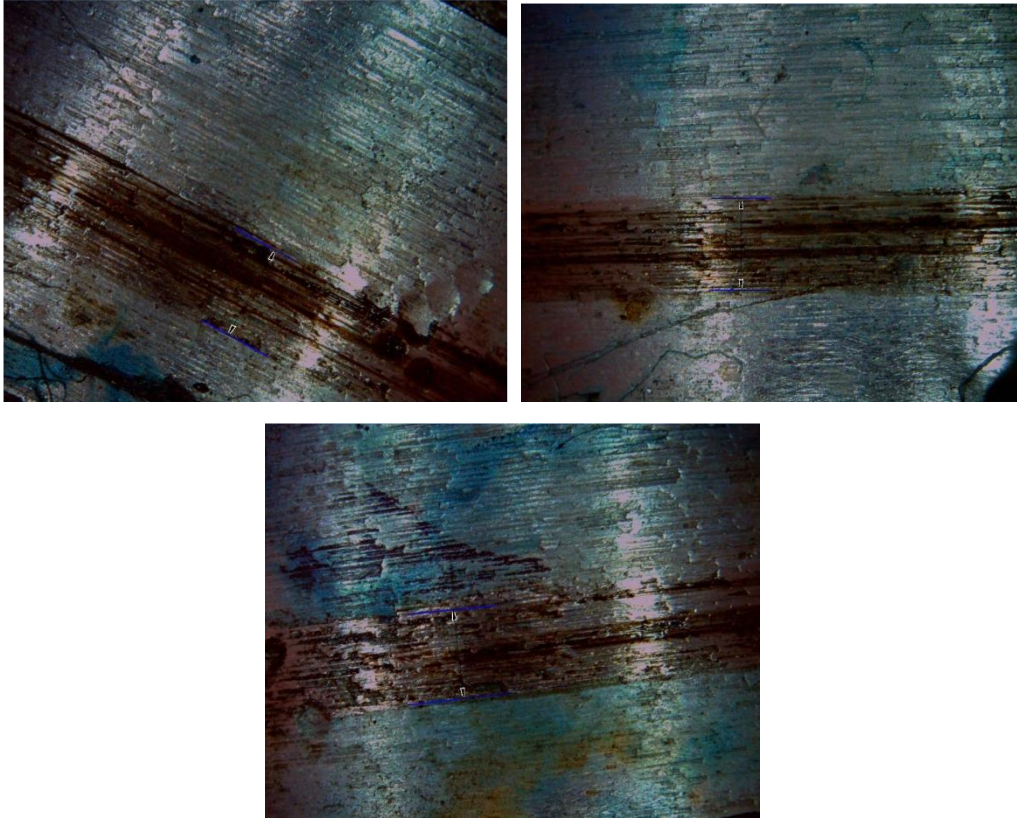
*Figure 7.13 - Treated second neck after 3 minutes of test*



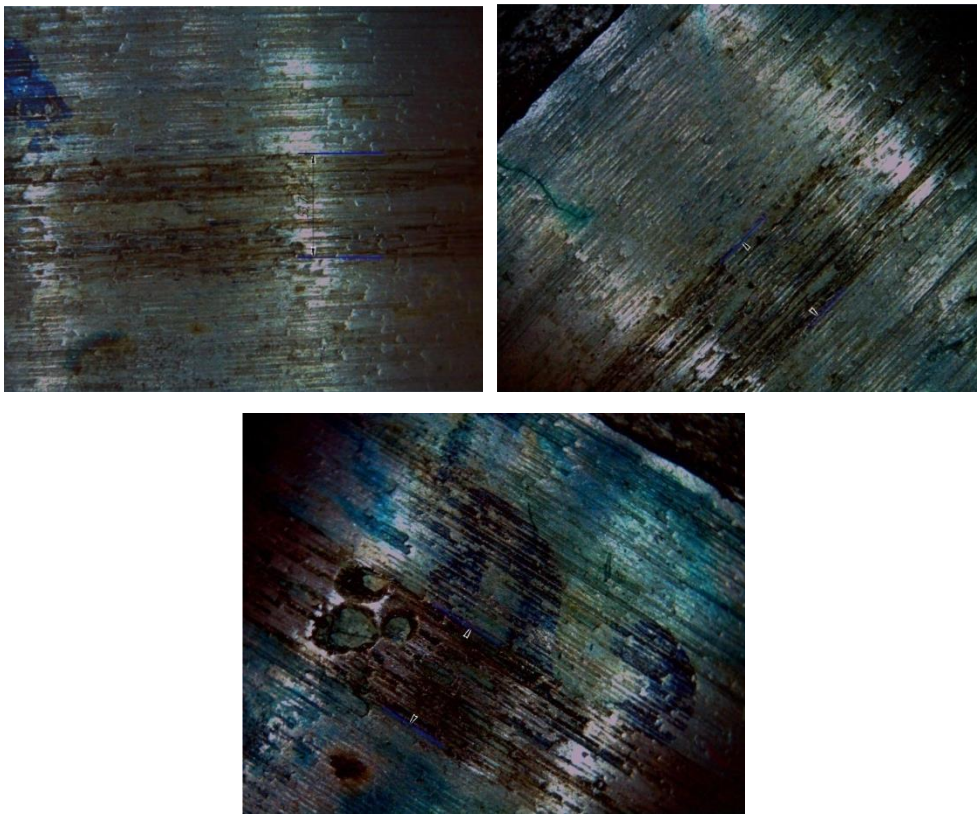
*Figure 7.14 - Treated the third neck after 3 minutes of testing*



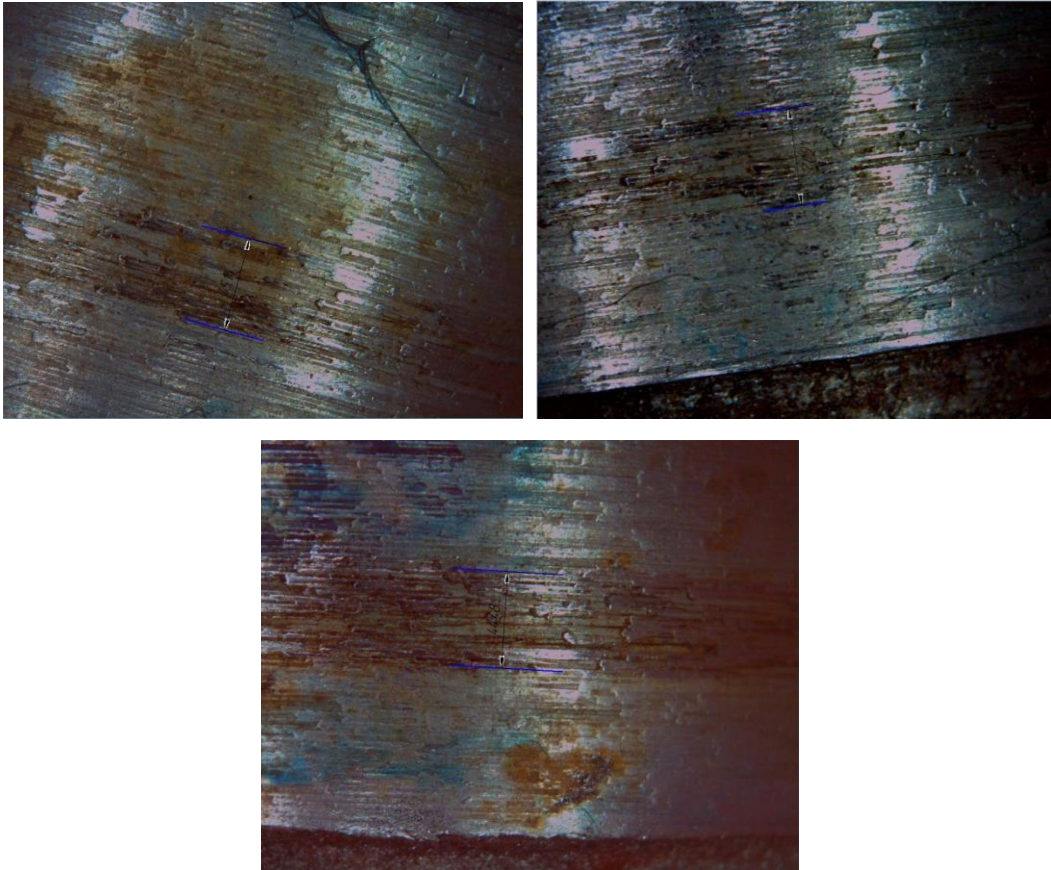
*Figure 7.15 - Raw sample after 6 minutes of testing*



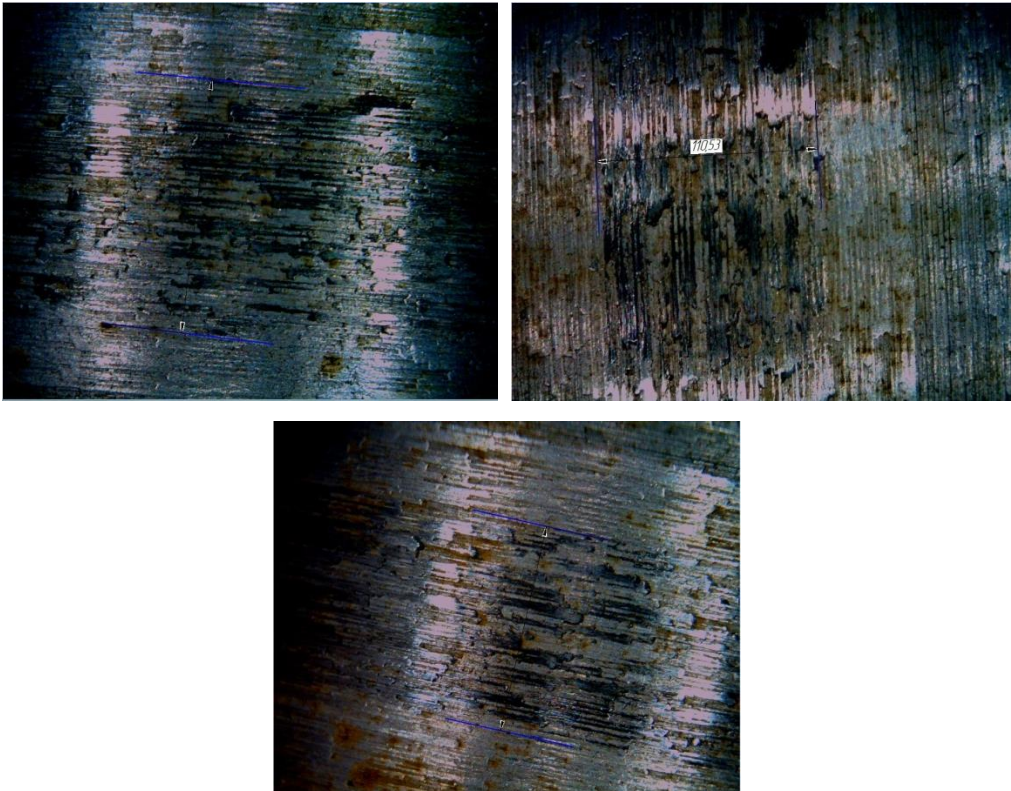
*Figure 7.16 - Treated the first neck after 6 minutes of testing*



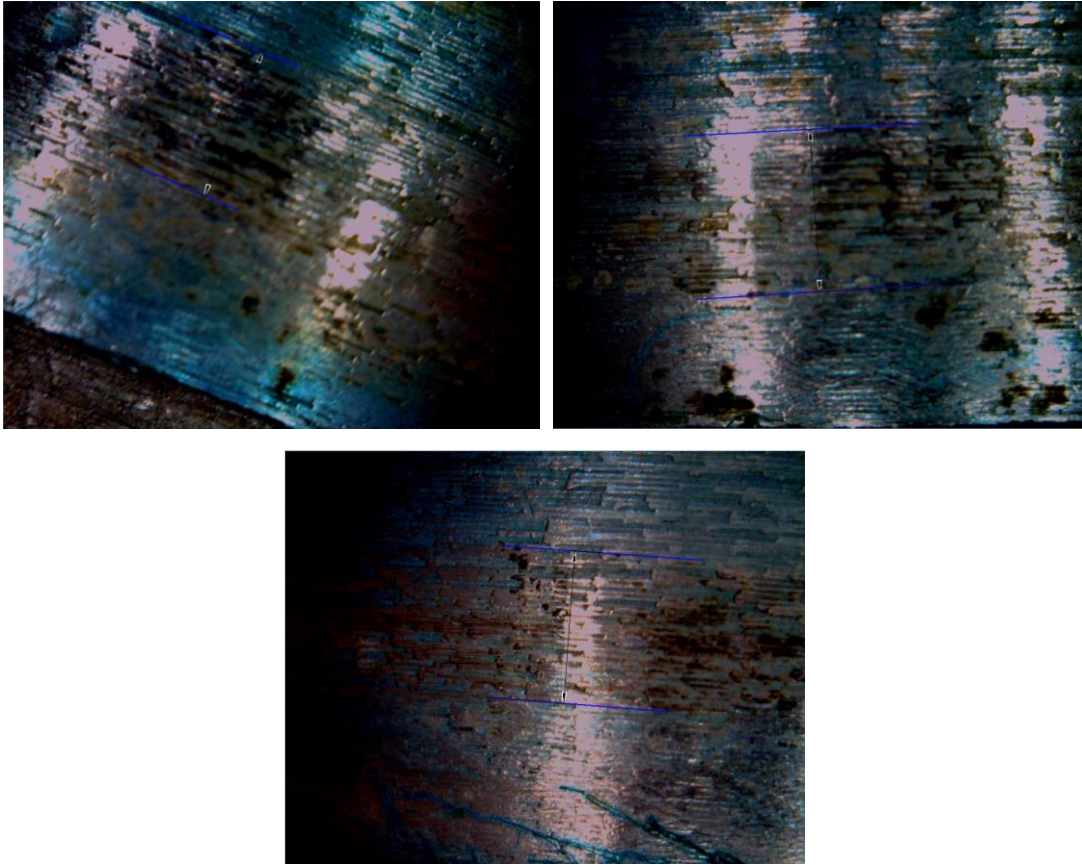
*Figure 7.17 - Treated the second neck after 6 minutes of testing*



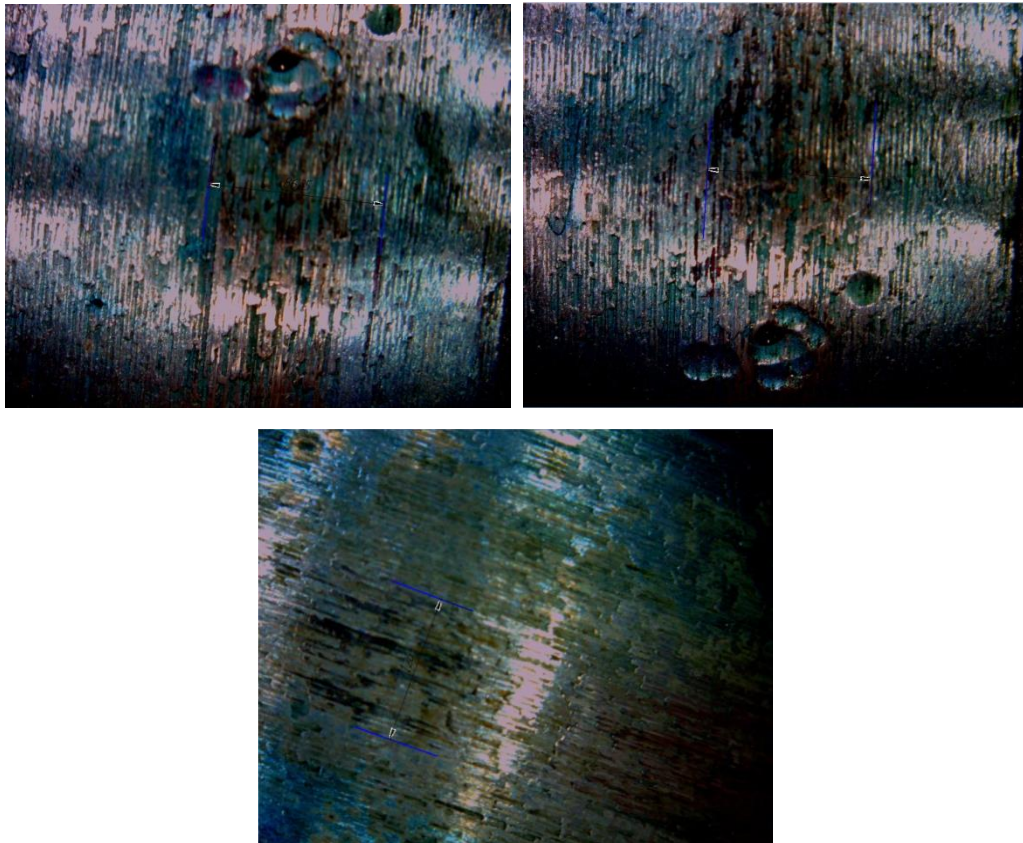
*Figure 7.18 - Treated the third neck after 6 minutes of testing*



*Figure 7.19 - Raw sample after 9 minutes of testing*



*Figure 7.20 - Treated the first neck after 9 minutes of testing*



*Figure 7.21 - Treated the second neck after 9 minutes of testing*

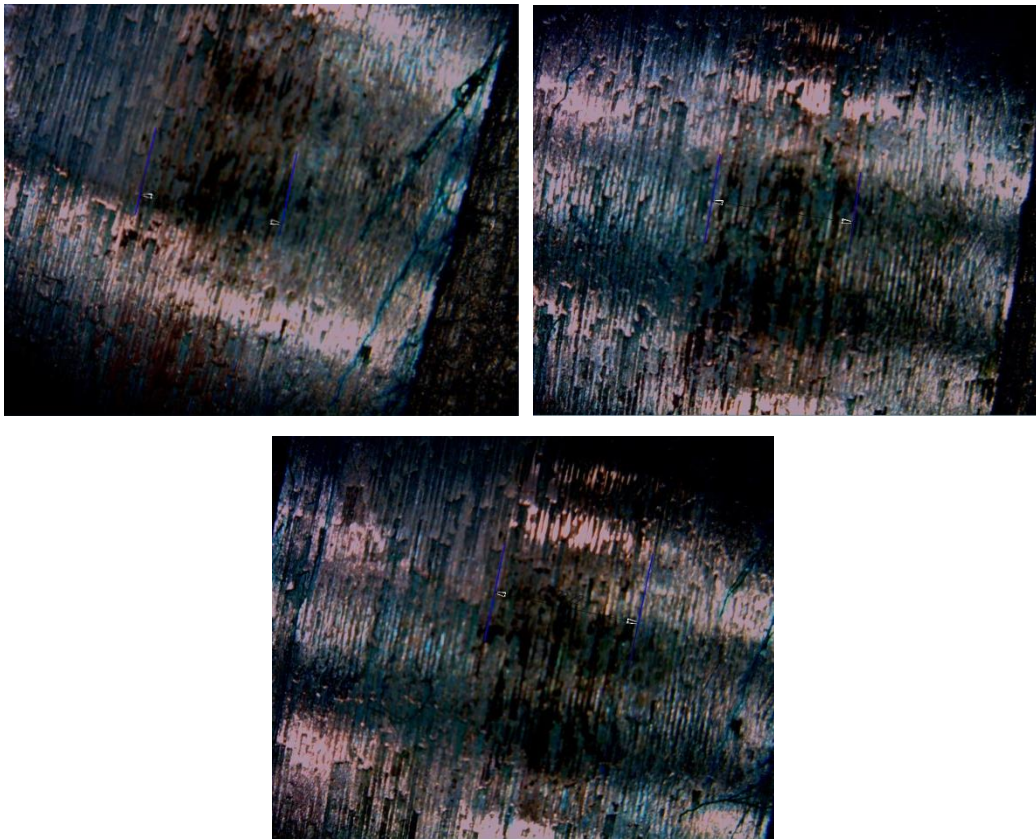
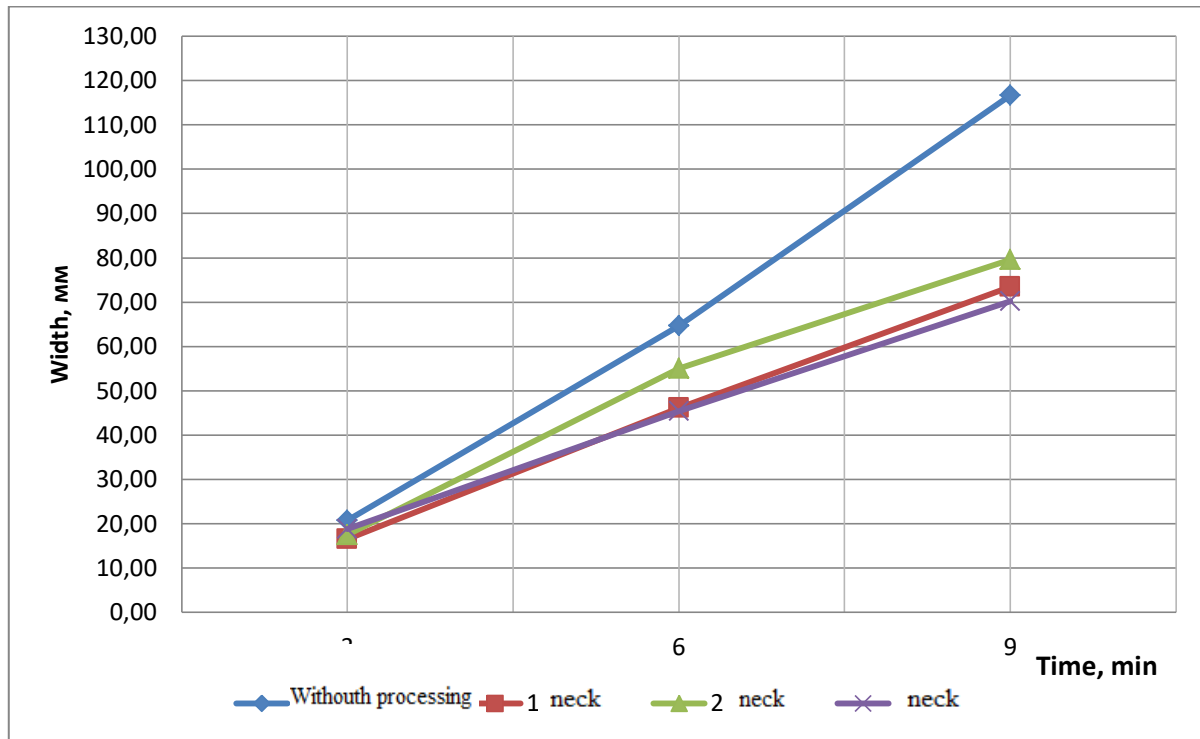


Figure 7.22 - Treated the third neck after 9 minutes of testing

Table 7.8 - Test results for wear resistance

Time, min.	Point	Track width, mm			
		Without processing	Neck		
			1	2	3
3	1	20,92	19,34	20,40	18,31
3	2	20,98	16,78	17,01	17,21
3	3	20,31	13,51	14,95	20,84
Average value		20,74	16,54	17,45	18,79
6	1	66,25	47,86	53,71	45,14
6	2	60,58	45,79	54,88	46,72
6	3	67,32	44,81	56,60	44,48
Average value		64,72	46,15	55,06	45,45
9	1	127,99	71,70	86,35	69,47
9	2	110,53	75,47	81,07	68,95
9	3	111,45	73,12	71,26	72,22
Average value		116,66	73,43	79,56	70,21





*Figure 7.23 - Graph of the width of the surface trace from the duration of the test*

### **Neural network modeling**

For further analysis of the study using the neuroimulator NeroPro v.0,25 based on the data of each stage of the experiment, formed a training and test sample, which built mathematical approximation models of the process of processing the work surface in a rotating magnetic field.

A model of the processing process (Fig. 7.24) depending on the hardness on time, frequency and initial hardness is created. A model of the machining process (Fig. 7.28) depending on the initial hardness and speed of rotation of the part during machining by a rotating magnetic field is created. The model of processing process (fig. 7.30) depending on initial hardness and speed of rotation of a detail at processing by epilation and activation by a rotating magnetic field is created.

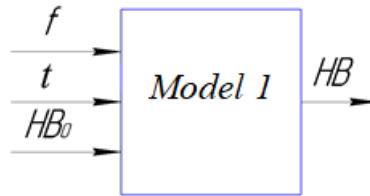


Figure 7.24 - Model of the processing process depending on the initial hardness, frequency, time

Verbal description of model 1 before and after modeling is presented in Appendix A. Significance of input parameters: frequency - 0.12, time - 0.32, initial hardness - 1. Test set and prediction are given in Figure 7.25.

N1	N2	N3	N4	N#	N4	Network forecast
2	100	215	0	1	0	224,2962
2	100	225	0	2	0	231,8703
2	100	235	0	3	0	239,6549
4	100	215	0	4	0	224,9638
4	100	225	0	5	0	234,9358
4	100	235	0	6	0	243,9925
6	100	215	0	7	0	226,5768
6	100	225	0	8	0	237,0253
6	100	235	0	9	0	245,1605
2	200	215	0	10	0	224,5171
2	200	225	0	11	0	233,4245
2	200	235	0	12	0	241,4376
4	200	215	0	13	0	225,4298
4	200	225	0	14	0	235,8019
4	200	235	0	15	0	244,7013
6	200	215	0	16	0	228,2086
6	200	225	0	17	0	237,9851
6	200	235	0	18	0	245,3373
2	300	215	0	19	0	224,8071
2	300	225	0	20	0	234,5265
2	300	235	0	21	0	243,4098
4	300	215	0	22	0	226,1378
4	300	225	0	23	0	236,6445
4	300	235	0	24	0	245,056
6	300	215	0	25	0	231,1086
6	300	225	0	26	0	239,1569
6	300	235	0	27	0	245,4593

Figure 7.25 - Test set and prediction of the result of model 1

According to the simulation results obtained: the dependence of hardness on frequency, presented in Figure 7.26, the dependence of hardness on the duration of exposure, shown in Figure 7.27.

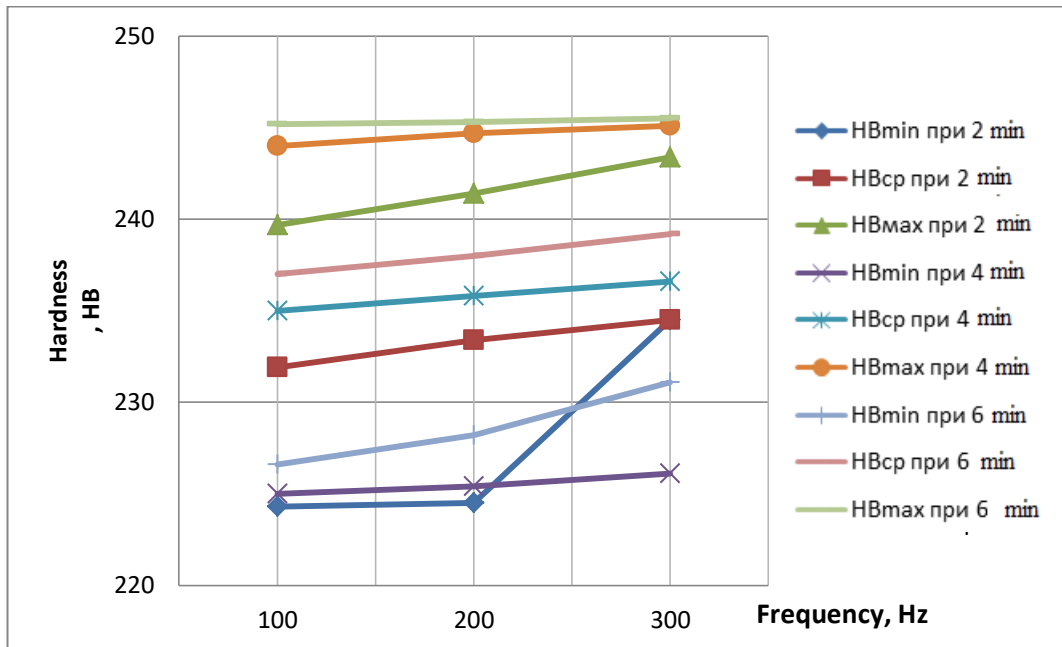


Figure 7.26 - Graph of the dependence of hardness on the excitation frequency

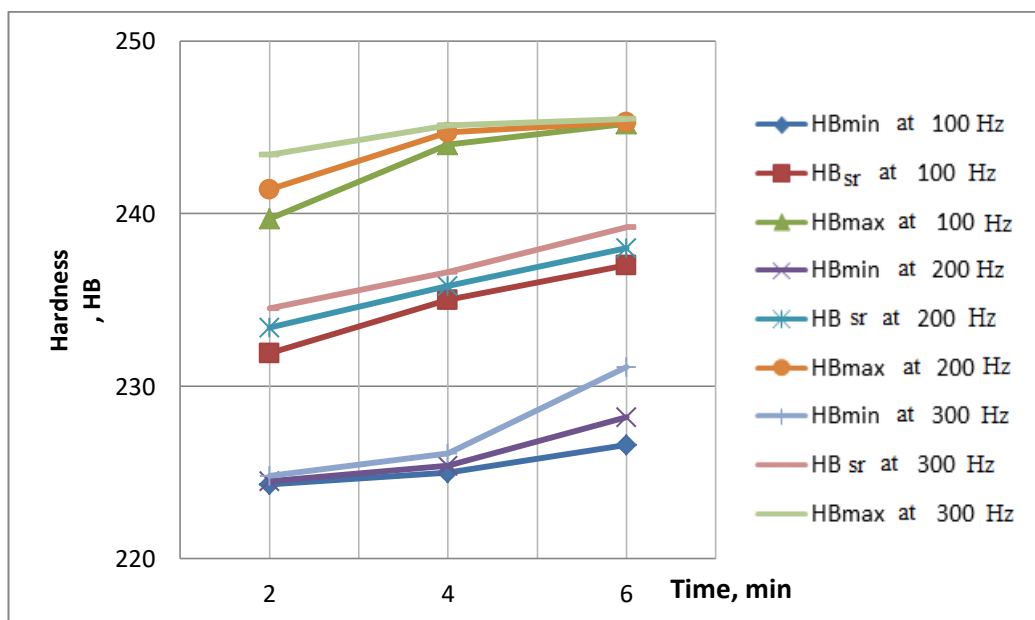


Figure 7.27 - Graph of the dependence of hardness on the duration of processing

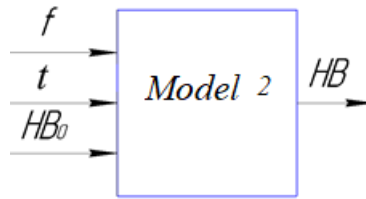


Figure 7.28 - Model of the process of processing by a rotating magnetic field depending on the initial hardness and speed of rotation of the part

Significance of input parameters: speed - 0.93, initial hardness - 1. The test set and prediction are given in Figure 7.29.

N1	N2	N3	N#	N3	[Network forecast]
12,5	215	0	1	0	237,4103
12,5	225	0	2	0	245,611
12,5	235	0	3	0	250,5935
16	215	0	4	0	227,4491
16	225	0	5	0	240,7926
16	235	0	6	0	246,5377
20	215	0	7	0	227,6515
20	225	0	8	0	231,7853
20	235	0	9	0	240,6734

Figure 7.29 - Test set and prediction of the result of model 2

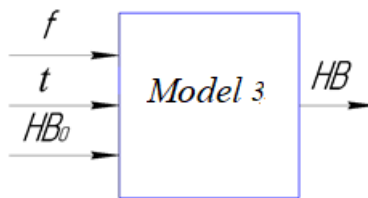


Figure 7.30 - Model of the epilation process and activation by a rotating magnetic field depending on the initial hardness and speed of rotation of the part

Significance of input parameters: speed - 0.76, initial hardness - 1. The test set and prediction are given in Figure 7.31.

	N1	N2	N3	
	12.5		210	0
		12.5	220	0
		12.5	230	0
		16	210	0
		16	220	0
		16	230	0
		20	210	0
		20	220	0
		20	230	0

Nº	N3	Network forecast
1	0	243,7575
2	0	245,7482
3	0	254,6819
4	0	234,4019
5	0	234,4305
6	0	245,1637
7	0	232,4893
8	0	233,4032
9	0	240,0381

Figure 7.31 - Test set and prediction of the result of model 3

According to the results of modeling the process of processing by a rotating magnetic field and epilation with activation by a rotating magnetic field depending on the initial hardness and speed of rotation of the part, the graph given in Figure 7.32

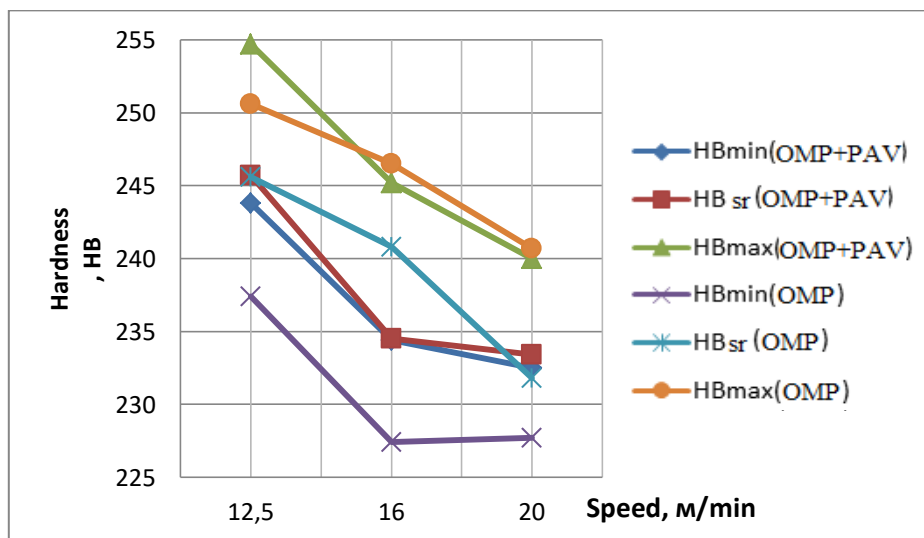


Figure 7.32 - Graph of the dependence of hardness on speed

To confirm the main hypothesis of the work, a method of experimental research was developed, which provides for the confirmation of the effect of epilation with activation by a rotating magnetic field on increasing the wear resistance of the surfaces of friction parts.

A tool for creating a rotating magnetic field has been developed and created.

According to the method, experimental studies were conducted. The results indicate the presence of extreme hardness values when predicting the resonant frequency of 200 Hz. The effect of extreme dependence of hardness on the duration of the process is revealed, which in our opinion is explained by the effect observed during long-term vibration processing. The effect of increasing the hardness with decreasing speed is explained by the positive effect of the duration of the rotating magnetic field, but within the limits of the previous remarks.

According to the results of modeling of multidimensional approximation dependences, the values of the acquired surface hardness are obtained, depending on the modes and conditions of treatment by a rotating magnetic field.

Based on the hypothesis and experimental studies, it can be argued that non-contact treatment with a rotating magnetic field allows to obtain positive changes in the quality of the surface layer, is to increase the hardness and wear resistance. It is established that there are extreme values of indicators at processing in the conditions of a resonance of frequency of a rotating magnetic field and natural frequency of processing of a surface.

Thus, the hypothesis is confirmed by the results of the experiment: increasing the wear resistance of the friction surfaces at 3 minutes of the test - 1.1... 1.2 times., At 6 minutes - 1.3... 1.4 times., At 9 minutes - 1.5... 1.6 times.

## SECTION 8

### RECOMMENDATIONS FOR THE USE OF NEURAL NETWORK ANALYSIS METHODS FOR OBJECT DIAGNOSIS

It is known that improving the accuracy and productivity of technological processes of machining depends on the quality of control of the actuators of the equipment. Along with the increase in technical requirements for them, the requirements for equipment and process control systems are growing, in particular - for the informativeness of diagnostic channels. The works [104, 105, 106, 116, etc.] present an analysis of methods and means of diagnostics of technological equipment and machining processes. However, despite significant progress in creating new tools, methods and techniques for diagnosing objects, the relevance of research in this direction is not reduced [103].

Among the methods of diagnostics of objects and processes that are actively developing, we should highlight the methods of their acoustic diagnostics and the creation of control systems on this basis [106,107,118].

The subject of research are methods of diagnosing the current characteristics of the state of objects.

The aim of the work is to create a concept of process control using acoustic control based on deep neural networks.

#### 1. Statement of the task

To formalize the mathematical description, the recommendations of [115] are used, in which the spectrum of the signal is represented by the spectral characteristics of the species

$$X_p(j\omega) = \int_{-\infty}^{+\infty} C_p(t) e^{-j\omega t} dt \quad (8.1)$$

The spectral density of the signal is determined by the formula:

$$S_x(\omega) = \lim_{T_p \rightarrow \infty} \frac{1}{2 \cdot T_p} M \left[ |X_p(j\omega)|^2 \right]$$

Estimation of spectral density is performed according to the known implementation of the  $Cp(t)$  signal by forming from it a discrete sequence  $x(n)$ ,  $n = 0, 1, \dots, N-1$  and processing this sequence in accordance with the quantized according to the sequence of finite length  $x(n)$ ,  $n = 0, 1, \dots, N-1$ :

$$X(e^{j\omega T}) = \sum_{n=0}^{N-1} x(n) e^{-j\omega T n}$$

Then the spectral density is estimated

$$P_x(\omega) = \frac{1}{N} |X(e^{j\omega T})|^2$$

In the general case, these estimates are not wealthy and there is a possibility of their fluctuation around the true value of the spectrum.

Using frequency filters with frequency response  $S(k)$  we obtain a modified spectrum of the object  $\Omega$  as a function of its properties  $Y$

$$A_k \{f_k[S(k)]\} \rightarrow \Omega(Y)$$

Bayes' theorem was used in the problem statement. Therefore, vmkoristovangi two main input positions: one known, the other - unknown (Fig. 8.1). The first is the hypothesis of the functional relationship of the frequency response with the state of the technological system, the second is the statistical data, which due to the transformation of Bayes' theorem form a posteriori information that has an error within the confidence interval.

The input data are the amplitude-frequency characteristics (obtained by measuring the state of the technological system using spectral analysis of the acoustic signal in the form of a response to the excitatory effect of "white noise"). The amplitudes of the discrete degrees of the obtained amplitude-frequency spectrum are determined based on the volume of calculations and the assumption of a decent error.



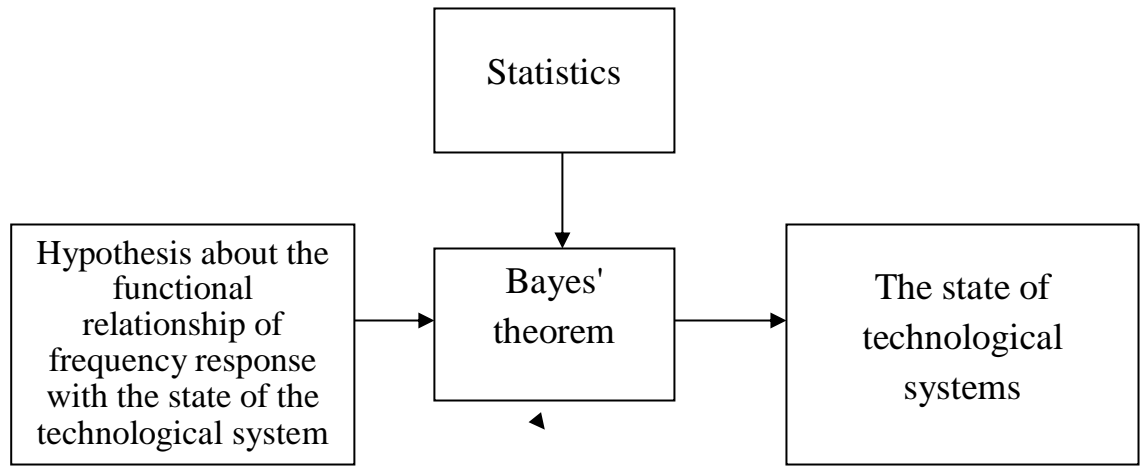


Fig. 8.1 Representation are using the Bayesian approach, taking into account [109].

The model that allows determined the relationship of frequency response with the physical and mechanical properties of materials is used to solve direct and inverse problems. The direct task is to determine the estimate  $\Delta$  error. Therefore, the sum of the quadratic deviations of the restored spectral characteristic is minimized within a given error. The inverse problem is solved by direct converters, we use the constructed network in the reverse order. Determine the inputs by known coordinates  $\bar{Y}$  and restore the original values  $\bar{X} \in S(k)$  (Fig.8.2).

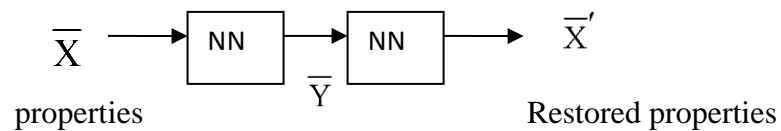


Fig.8.2 The concept of building a neural network model

The evaluation of the neural network should not exceed the recovery error  $\text{sum}(\bar{X} - \bar{X}')^2$  .

$$\begin{aligned} \bar{X}' &= F_y [A_i(f_i)] \\ \bar{Y} &= F_x [x_j, y_j, z_j] \end{aligned} \tag{8.2}$$

$$i = 1..N$$

$$j = 1..M$$

$$M \leq N$$

When directly solving the problem, the model is built from unknown data, and then, thanks to training, we obtain the necessary accuracy to determine the properties of objects.

In the inverse problem, knowing the physical and mechanical properties of materials or the state of the technological system, neural network training is performed, followed by restoration of the frequency response spectrum of samples with physical and mechanical properties of materials, which must differ from the input no more than  $\chi_{II}$  (Fig. 8.3).

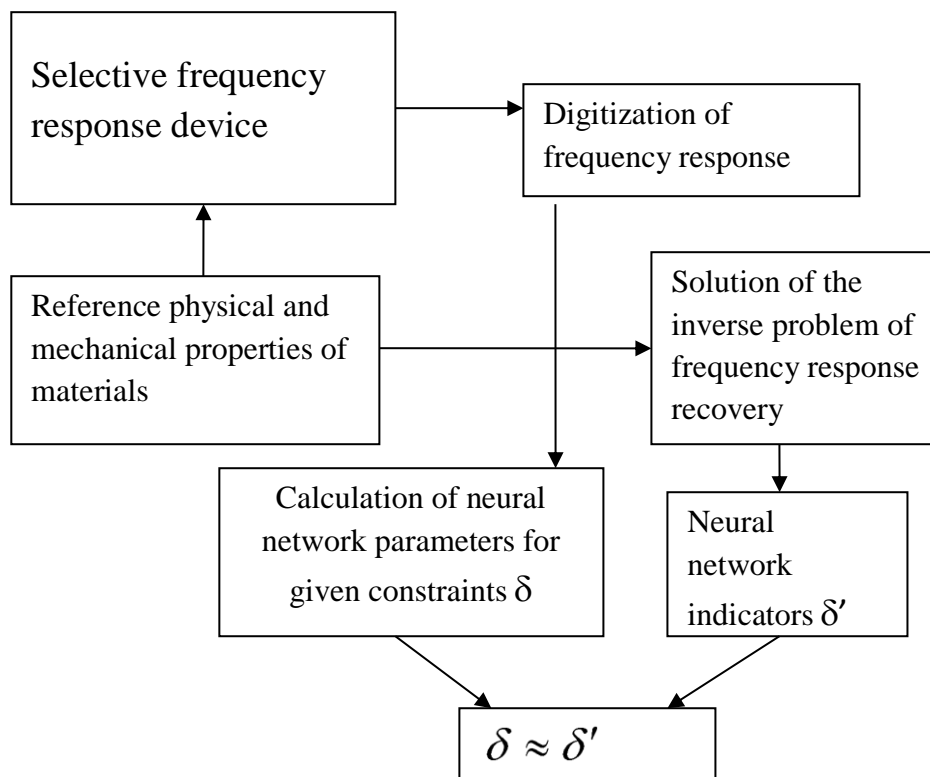


Fig. 8.3 Information model of the process

The initial data uses the notion of frequency response (inputs are the amplitudes of discrete stages of frequency response). The number of such stages

is determined by the degree of discreteness and is chosen based on the amount of computation, capacity and the required accuracy of the model.

$$\bar{X} \ni (x_i, y_i, z_i)$$

$$\bar{Y} \ni [A_j(f_j)] = F_x(x_i, y_i, z_i)$$

$$\bar{X}' \ni (x'_i, y'_i, z'_i) = F_y[A_i(f_i)]$$

$$\bar{Y}' \ni [A'_i(f_i)] = F_x[x'_i, y'_i, z'_i]$$

$$\left\{ \begin{array}{l} \sum_i^N [(x_i - x'_i)^2 + (y_i - y'_i)^2 + (z_i - z'_i)^2] \rightarrow \min \\ \sum_j^M [(A_j(f_j) - A'_j(f_j))]^2 \rightarrow \min \\ |\bar{X} - \bar{X}'| \leq \delta \\ |\bar{Y} - \bar{Y}'| \leq \delta' \end{array} \right.$$

$$|x_i - x'_i| \leq \delta$$

$$|y_i - y'_i| \leq \delta$$

$$|z_i - z'_i| \leq \delta$$

$$|A(f_i) - A'_i(f)| \leq \delta'$$

Each amplitude  $A_i(f_i)$  has a distribution of probability characteristics. For a given input  $X$ , the neural network restores the value of  $Y$ . For a given frequency response samples created a mathematical model that allows you to accurately restore  $Y' = F_x[x, y, z]$ . To do this, the optimization problem is solved, which has an objective function and has limitations.

In the works [107, 118] the authors consider issues related to the diagnosis of the technological system. The main task of diagnostics is to recognize the state of the object in conditions of limited information [102]. The recognition algorithm is partly based on diagnostic models that establish the relationship

between the states of objects and their reflections in the space of diagnostic features [46].

The authors [110, 111] proposed to use acoustic control for such algorithms, based on the amplitude - frequency characteristics of the natural oscillations of objects.

Earlier, in [46,113], it was suggested and partially confirmed the assumption that as an informative source of the diagnostic signal should use its amplitude-frequency response of the natural oscillations of the object in the acoustic range.

Among the methods of acoustic control are: active - use radiation and reception of acoustic signals, and passive - based only on the reception of acoustic signals [112].

Acoustic control methods are based on the interaction with the controlled product of elastic oscillations and waves of a wide range of frequencies [114, 117]. These methods are most widely used for non-destructive testing of multilayer structures. The main ones are low-frequency methods, ultrasonic method of passage and, to a lesser extent, reverberation and acoustic-topographic, although their possibilities are not fully disclosed. Obviously, the main problem is the methodology and mathematical apparatus used to process acoustic signal data. Therefore, this paper proposes a method of acoustic diagnostics for the state of the technological system, as well as further data processing using neural networks.

Given the special importance of the problem, the authors of the article propose a comprehensive approach in which the control and diagnostic processes are a procedure for creating a reference model of the control object and maintaining this model in the current state during the technological operation. The basis of this approach is the spectrum of the acoustic signal reflected from the elements of the technological system and the system of its transformation (Fig. 8.4).

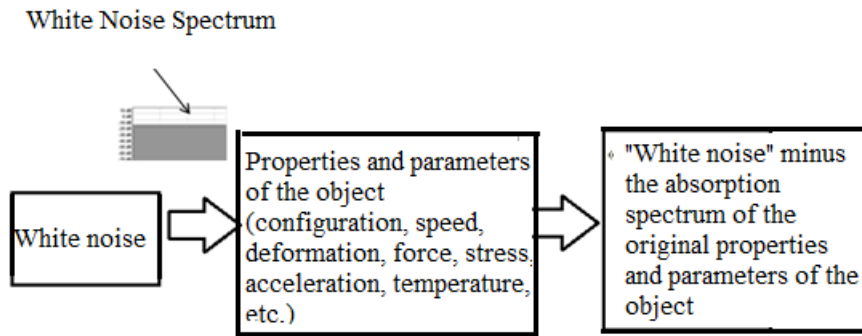


Fig. 8.4 Block diagram of creating a reference model of the technological system

The creation of the reference model is based on the hypothesis of the informative capabilities of the spectrum of the acoustic signal as a source of data on the properties and parameters of the object. As shown in [111, 113], the spectrum of intrinsic oscillations of the object is the most informative about the various properties and parameters of the object. However, the informative possibilities of the diagnostic spectrum of the acoustic signal are significantly expanded by excitation of the spectra of forced oscillations by "white noise" induced by the emitter in the test range.

To implement this approach, the following is adopted:

$W(f)$  - excitation signal of the object "white noise";

$R[W(f)]$  - the reaction of the object to the excitation of "white noise";

$X_k, X_1, \dots, X_r, \dots$  - properties and parameters of the object (configuration, speed, deformation, force, stress, velocity, acceleration, temperature, etc.)

$$R[W(f)] = F\{X_k, X_1, X_r, \dots\}$$

The task of diagnosis and creation of a reference model of the object is to determine the properties and parameters of the object  $X_k, X_1, \dots, X_r, \dots$  by the reaction  $R[W(f)]$  (Fig.8.5).

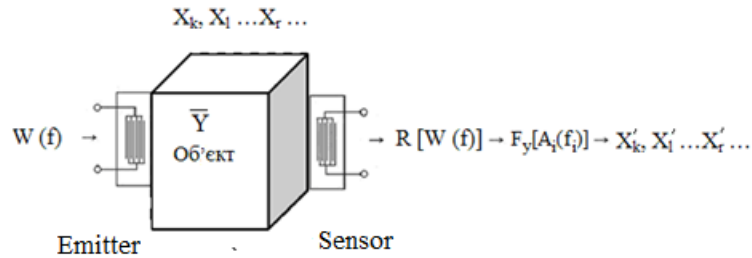


Fig.8.5 Information model for determining the properties and parameters of the object:

$$W(f) \rightarrow \text{Object} \rightarrow R[W(f)] \rightarrow F_y[A_1(f_1)] \rightarrow X_k, X_1 \dots X_r$$

The emitter and receiver of the diagnostic device are reversible piezoelectric elements, which are fed (emitter) and from which are removed (sensor) signals. Since the diagnostics of the object is performed relative to the reference signal "white noise", this approach allows you to normalize the output diagnostic signals relative to the reference signal.

In [45, 110] we showed that the solution of the transformation  $X_k, X_1 \dots, X_r \dots = F \{X_k, X_1 \dots X_r \dots\}$  rekomenduyet'sya vykonuvaty iz zastosuvanniam neyromerezhevoho modelyuvannya. Kozhen vymir maye maksimal'no mozhlyvyi zakhyst vid vpadkovykh fluktuatsiy syhnalu. Tse dosyahayet'sya tym, shcho pry kozhniy realizatsiyi elementiv planu eksperymentu vymiryuvannya userednyuyut' v tsykli z 100 poslidovnykh skanuvan' spektra z dyskretnistyu spektra v 178,3 vid 0 do 20000 Hts. Zavdyaky povno faktornoho eksperymentu randomyzatsiyeyu spoluchen' faktoriv bulo zformovano bazu danykh, de faktoramy ye koordynaty pozytsionuvannya vykonavchoho mekhanizmu eksperymental'noho stendu . Akustychnyy spektr vidhuku, shcho predstavlyaye soboyu sumu zbudzhenykh, pohlynenykh i vidobrazhenykh akustychnykh khvyl' piddayet'sya obrobtsi na hlybokykh neyronnykh merezhakh. Rezul'tatom takoyi obrobky ye model', shcho intehrue osoblyvosti bahatosharovykh pertseptroniv i kart Kokhonena. Take ob'yednannya mozhlyve za dopomohoyu neyronnykh merezh kaskadnoyi konfihuratsiyi i modyfikovanykh neyropodobnykh elementom. U prohramnomu paketi NeuroPro-0.25 nadana mozhlyvist' zastosuvaty otrymanu model' dlya prohnozuvannya

vlastyvostry i parametriv ob'yekta po amplitudo chastotnykh kharakterystykakh i tym samym zabezpechyty funktsionuvannya etalonnoyi modeli ob'yektu. Dlya doslidzhen' vykorystano alhorytm shvydkoho obchyslennya dyskretnoho peretvorennya Fur'ye za dopomohoyu FFT-analizatora, na vkhid yakoho nadkhodyt' tsyfrovyy audio syhnal. Analizator vybyraye z syhnalu poslidovni intervaly ( «vikna»), na yakykh obchyslyuyet'sya spektr, yakyy vidobrazhayet'sya u vyhlyadi hrafika zalezhnosti amplitudy vid chastoty (Fig. 8.6).

Each measurement has the maximum possible protection against accidental signal fluctuations. This is achieved by the fact that at each implementation of the elements of the plan of the experimental measurement is averaged in a cycle of 100 consecutive scans of the spectrum with a spectral discreteness of 178.3 from 0 to 20,000 Hz. Due to the full-factor experiment, a database was formed by randomization of combinations of factors, where the factors are the coordinates of the positioning of the executive mechanism of the experimental stand.

The acoustic response spectrum, which is the sum of excited, absorbed and reflected acoustic waves, is processed on deep neural networks. The result of such processing is a model that integrates the features of multilayer perceptrons and Kohonen maps. Such integration is possible with the help of neural networks of cascade configuration and a modified neuro-like element.

The software package NeuroPro-0.25 provides an opportunity to use the obtained model to predict the properties and parameters of the object by the amplitude and frequency characteristics and thus ensure the functioning of the reference model of the object.

An algorithm for fast calculation of a discrete Fourier transform using an FFT analyzer using a digital audio signal is used for research. The analyzer selects from the signal sequential intervals ("windows"), which calculates the spectrum, which is displayed as a graph of the amplitude of the frequency (Fig. 8.6).

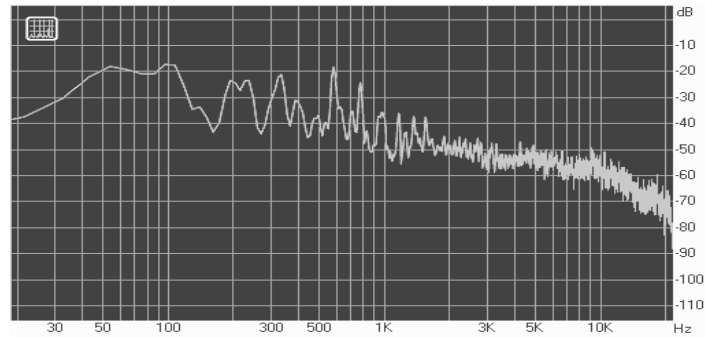


Fig. 8.6 FFT analyzer display

Similar to band analyzers, a logarithmic scale along the frequency and amplitude axes is usually used. But due to the linear arrangement of the FFT bands in frequency, the spectrum may look insufficiently detailed at lower frequencies or excessively oscillating at higher frequencies.

The horizontal line on the FFT analyzer displays white noise that has equal energy in equal linear frequency intervals.

The parameter  $N$  - the number of analyzed signal responses - is crucial for the type of spectrum. The larger  $N$ , the denser the grid of frequencies at which the FFT decomposes the signal, and the more details on the frequency seen in the spectrum.

Longer signal sections are analyzed to achieve higher frequency resolution. If the signal within the FFT window changes its properties, the spectrum displays the average signal information from the entire window interval.

To analyze rapid changes in the signal, the window length  $N$  is assigned to small. Then the resolution of the analysis increases with time, and decreases with frequency. Thus, the resolution of the frequency analysis is inversely proportional to the solution over time, which can be explained by the uncertainty ratio.

To create an informative spectrum of the acoustic signal, the hypothesis of its information content when the object is disturbed by the influence of "white noise", which, along with the detection of information-active frequencies of the spectrum, allows forming a single initial conditions in the diagnostic process.



The construction of a neural network reference model for the diagnosis of the current characteristics of the object begins with the selection of the diagnosed characteristics of the object, which are determined by the control tasks.

The solution of these problems is aimed at improving the quality and productivity of technological machines and processes.

## REFERENCES

1. Могилев А., Пак Н., Хеннер Е. и др. Информатика: учебное пособие. – М.: АСТ-ПРЕСС: Инфорком – Пресс, 1999.– 496 с.
2. Веретенникова Е. Г., Патрушина С. М., Савельева Н. Г. Информатика. Учебное пособие. – Ростов-на-Дону: Изд. центр «МарТ», 2002. – 416 с.
3. Острейковский В. А. Информатика Уч. пос. – М.: Высш. шк., 2003. – 319 с.
4. Пузикова В. С. Информация и научная картина мира. Автореферат диссертации на соискание степени кандидата философских наук. 2005 г.
5. Абдеев Р. Ф. Философия информационной цивилизации. – М.: ВЛАДОС, 1994. – 336 с.: 58 ил.
6. Винер Н. Кибернетика и общество. – М.: Изд-во иностр. лит., 1958. – 200 с.
7. Бриллюэн Л. Наука и теория информации. – М.: Изд. «Медиа», 1960. – 390 с.
8. Шеннон К. Работы по теории информации и кибернетике. – М.: Изд. иностр. лит., 2002. – 830 с.
9. Эшби У. Р. Введение в кибернетику. – М.: ИЛ, 1958. – 432 с.
10. Асмус В. Ф. Античная философия. – М.: Высш. шк., 1998. – 400 с.
11. Дриш Г. Витализм: Его история и система. Изд. – М.: «ЛКИ», 2. 2007. – 280 с.
12. Колин К. К. Философские проблемы информатики. – М.: БИНОМ, 2010. – 264 с.
13. Канке В. А. Философия математики, физики, химии, биологии. – М.: КНОРУС, 2011. – 368 с.
14. Колин К. К. Философские и научно-методологические проблемы современной информатики // Открытое образование. – 2007. – № 3 – 62.
15. Урсул А. Д. Информатизация общества. – М.: Наука, 1971. – 295 с.
16. Урсул А. Д. Природа информации. Философский очерк. – М.: Политиздат, 1968. – 288 с.

17. Лаврович Н.И. Оценка надежности и долговечности деталей по параметрам колебательного процесса. Динамика систем, механизмов и машин : Тез. Докл. Международн. Конферен. 26-28 октября 1999 г. – Омск, 1999. – С. 88–89.
18. Наумов В.А., Асауленко А.П., Паврович Н.И. Закономерности простейшей колебательной системы с медленно изменяющимися параметрами. Расчеты на жесткость и прочность в машиностроении: Межвузовский сборник научных трудов ОмПИ. – Омск: ОмПИ, 1981. – С. 52–56.
19. Хейлен, В. Модальный анализ: теория и испытания [Текст] / В. Хейлен, С. Ламменс, П. Сас. – М.: ООО «Новатест», 2010. – 319 с.
20. Brillhart, R. Advanced GVT Testing of the Gulfstream G650 [Text] / R. Brillhart, K. Napolitano, L. Morgan [et al.] // J. Sound and Vibr. – 2011. – No. 8. – P. 6–9.
21. Modal Parameter Estimation for Large, Complicated MIMO Tests [Text] / A. Peter, R. Singhal, B. Peeters [et al.] // J. Sound and Vibr. – 2006. – No. 1. – P. 14–20.
22. Allemang, R. J. Techniques for Evaluation of Modal Vector Contamination [Text] / R. J. Allemang, A. W. Phillips // Journal of Sound and Vibration. – 2015. – No. 49(1). – P. 8–11.
23. Solar Impulse — How to validate the numerical model of a superlight aircraft with A340 dimensions! [Text] / M. Böswald, Y. Govers, A. Vollan [et al.] // Proceedings of ISMA2010 International Conference on Noise and Vibration Engineering including USD2010, Leuven, Belgium. – 2010. – P. 2451–2466.
24. Allen, B. An Inertially Referenced Noncontact Sensor for Ground Vibration Tests [Text] / B. Allen, C. Harris, D. Lange // J. Sound and Vibr. – 2010. – No. 11. – P. 13–15.
25. Черняева Т.П., Грицина В.М., Михайлов Е.А., Остапов А.В. Корреляция между упругостью и другими свойствами циркония. Научно-техн. комп. "Ядерный топливный цикл". ННЦ Харьковский физ.-тех. институт, Харьков, Вопросы атомной науки и техники. 2009. – № 4–2. – С. 206–217.
26. Приходько О. А., Манойлов В. В. Определение модуля нормальной упругости материала на основе преобразования Фурье акустических колебаний образца // Научное приборостроение. – 2009. – Том 19, № 3. – С. 93–96.

27. Тимошенко С.П. Прочность и колебания элементов конструкций. – М.: Наука, 1975. – 704 с.
28. ГОСТ 25095-82. Сплавы твердые спеченные. Метод определения модуля упругости (модуля Юнга).
29. Баранов В.М. Ультразвуковые измерения в атомной технике. М.: Атомиздат, 1975.
30. Заявка РФ на изобретение 92012893/28, кл. МКИ О 01 N 29/12, опубл. 20.08.95.
31. Ключев В.В. Приборы для неразрушающего контроля материалов изделий. – М.: Машиностроение, 1986. – 488 с.
32. Измерение модуля Юнга сверхтвердых материалов с помощью сканирующего зондового микроскопа “НаноСкан”. А. С. Усеинов. Приборы и техника эксперимента. – 2003. – № 6. – С. 1–5.
33. Расчет упругих постоянных материала по собственным частотам колебаний круглой пластины / В. Т. Минченя, Д. А. Степаненко, Е. Н. Юрчик // Вестник Белорусского национального технического университета : научно-технический журнал. – 2009. – № 6. – С. 37–42.
34. Ковалевський С.В., Глушич К.С. Удосконалення робочих поверхонь деталей машин методом епіамірування. / «Молода наука – прогресивні технологічні процеси, технологічне обладнання і оснащення» збірник всеукраїнської науково-технічної конференції з міжнародною участю – Краматорськ: ДДМА, 2018. – 95 с.;
35. Лолазде Т.Н. Прочность и износостойкость режущего инструмента / Т.Н. Лолазде – М.: Машиностроение, 1982. – 320 с.
36. Технологические процессы повышения работоспособности металлорежущего инструмента / А. С. Верещака, В. В. Высоцкий, Б. Я. Мокрицкий, П. А. Саблин ; под общ. ред. А. С. Верещаки. – Комсомольск-на-Амуре : ФГБОУ ВПО «КНАГТУ», 2013. – 208 с.
37. Скрынченко Ю.М. Работоспособность и свойства инструментальных сталей / Ю.М. Скрынченко, Л.А. Позняк – К.: Наукова думка, 1979. – 168 с.
38. Кремнев Л.С. Особенности разрушения инструментальных материалов / Л.С. Кремнев // Металловедение и термическая обработка материалов. – 1994. – № 4. – С. 17–22.
39. Геллер Ю.А. Инструментальные стали / Ю.А. Геллер – м.: Металлургия, 1983. – 527 с.

- 40.Самотугин С.С. Плазменное упрочнение инструментальных материалов / С.С.Самотугин, Л.К.Лещинский – Донецк: Новый мир, 2002. – 338 с.
- 41.Пименов Ю.В., Вольман В.И., Муравцов А.Д. «Техническая электродинамика» – М.: «Радио и связь», 2000. – 536 с.
- 42.Ступин В.А. Определение упругих констант металлов ультразвуковым резонансным методом: Препринт. НИИАР-18(664). – М.:ЦНИИАтоминформ, 1985. – 16 с.
- 43.ElaStic: A tool for calculating second-order elastic constants from first principles / R. Golezorkhtabar [et al.] // Computer Physics Communications. – 2013. – Vol. 184, № 8. – P. 1861–1873.
- 44.ГОСТ 25095–82. Сплавы твердые спеченные. Метод определения модуля продольной упругости. – М.: Изд-во стандартов, 1983. – 7 с.
- 45.Kovalevskyy S. V. Acoustic Monitoring with Neural Network Diagnostics / S. V. Kovalevskyy, O. S. Kovalevska // American Journal of Neural Networks and Applications. – 2015. – Vol. 1, No. 2. – P. 39–42. – doi: 10.11648/j.ajjna.20150102.12
- 46.Діагностика технологічних систем і виробів машинобудування (з використанням нейромережевого підходу) : монографія / С.В. Ковалевський, О.С. Ковалевська, Є.О. Коржов, А.О. Кошевой ; за заг. ред. д.т.н., проф. С.В. Ковалевського. – Краматорськ : ДДМА, 2016. – 186 с.
- 47.Счастливец В.М. Калетина Ю.В., Фокина Е.А. Мартенситное превращение в магнитном поле. Екатеринбург: УрО РАН, 2007. – 322 с.
- 48.Комшина А.В., Помельникова А.С., Шипко М.Н. Влияние импульсных магнитных полей на микротвердость ферро- и парамагнитных сплавов // Инновационная деятельность предприятий по исследованию, обработке и получению современных материалов и сплавов: матер. II междунар. конф. Орск, 2011. – С. 384–390.
- 49.Гринкевич В.А., Шевченко Т.Н., Краев М.В., Краева В.С., Бондарев С.В. Комбинированная обработка давлением сталей с применением внешнего магнитного поля // Обработка материалов давлением. 2013. – № 4 (37). – С. 79–82.
- 50.Лоу Дж.Р. Связь хрупкого разрушения с микроструктурой. Структура металлов и свойства. М.: Государственное научно-техническое издательство литературы по черной и цветной металлургии, 1957. – С. 170–189.

51. Atherton D.L., Jiles D.C. Effects of Stress on Magnetization // NDT International. 1986. Vol. 19. P. 15–19.
52. Jiles D.C. The Effect of Compressive Plastic Deformation on the Magnetic Properties of AISI 4130 Steels with Various Microstructures // J. Phys. D: Appl. Phys. 1988. pp. 1196–1204.
53. Ильясова А.И. Анализ влияния магнитного поля на свойства стали линейной части магистральных трубопроводов // Нефтегазовое дело. Сетевое издание. – 2019. – №2. – С.156–168.
54. Загидуллин Р.В., Мужичкий В.Ф., Загидуллин Т.Р. Расчет остаточной намагниченности деформированной стальной пластины // Заводская лаборатория. Диагностика материалов. – 2005. – № 2. – Т. 71. – С. 25–28.
55. Александров П.А., Бударрагин В.В., Шахов М.Н. Механические свойства некоторых материалов в магнитном поле // Вопросы атомной науки и техники. Сер. Термоядерный синтез. – 2005. – Вып. 1. – С. 24–30.
56. Фролов К.В., Махутов Н.А., Хуршудов Г.Х., Гаденин М.М. Прочность, ресурс и безопасность технических систем // Проблемы прочности. – 2002. – № 5. – С. 8–18.
57. Теплинский Ю.А., Агинея Р.В., Кузьбожев А.С., Андронов И.Н. Исследование особенностей изменения магнитных параметров стали 17Г1С в условиях одноосной растягивающей нагрузки // Контроль. Диагностика. – 2004. – № 1. – С. 14–16.
58. Горкунов Э.С., Митропольская С.Ю., Вичужанин Д.И., Туева Е.А. Применение магнитных методов для оценки нагруженности и поврежденности стали Х70 // Физическая мезомеханика. – 2010. – Т. 13, № 1. – С. 73–82.
59. Моргунов Р.Б. Спиновая микромеханика в физике пластичности // Успехи физических наук. – 2004. – Вып. 174 (2). – С. 131–152.
60. Краев М.В., Гринкевич В.А., Шевченко Т.Н., Краева В.С. Комбинированная обработка давлением сталей с применением внешнего магнитного поля // Обработка материалов давлением. – 2012. – № 3 (32). – С. 116–120.
61. Горкунов Э.С., Смирнов С.В., Задворкина С.М., Вичужанин Д.И., Митропольская С.Ю. Влияние накоплений деформации сдвига и поврежденности при кручении на магнитные характеристики стали // Физическая мезомеханика. – 2004. – Т. 7, № 81–2. – С. 311–314.
62. Худяков М.А., Алтынова Р.Р. Влияние постоянного магнитного поля

на циклическую трещиностойкость и коррозионную стойкость стали 17Г1С // Нефтегазовое дело. – 2006. – Т. 4, № 1.

63. Зими́на Т. Наука и жизнь. Новости науки и техники. ИКБ (дата обращения: 25.02.2019)
64. Новиков В.Ф., Быков В.Ф., Муратов К.Р. Ускоренное определение величины скорости коррозии // Актуальные проблемы строительства и эксплуатации газовых скважин, промышленного обустройства месторождений и транспорта газа: сб. науч. тр. ООО «ТюменНИИгипрогаз». – М.: Недра, 2002. – С. 120–123.
65. Вопросы теории и практики магнитной обработки воды и водных систем // Матер. Второго Всесоюзного семинара «Вопросы теории и практики магнитной обработки воды и водных систем». – М., 1971. – 316 с.
66. Бессонов, Л. А. Теоретические основы электротехники. Электромагнитное поле : учебник для бакалавров / Л. А. Бессонов. – 12-е изд., испр. и доп. – М. : Издательство Юрайт, 2014. – 317 с.
67. Бессонов Л. А. Теоретические основы электротехники. Электромагнитное поле : учебник для бакалавров / Л. А. Бессонов. – 12-е изд., испр. и доп. – М. : Издательство Юрайт, 2014. – 317 с.
68. [Miningwiki.ru/wiki/Проходческий комбайн КПД](http://Miningwiki.ru/wiki/Проходческий_комбайн_КПД)
69. «Спосіб автоматичної віброобробки металевих деталей та автоматизована електромеханічна система для його здійснення»  
Номер патенту: 63094 Оpubліковано: 15.01.2004 Автори: Шеремет О. І., Панкратов А. І. Виданий: – 2011. – 4с.
70. Верстат для віброобробки  
Номер патенту: 24253 Оpubліковано: 07.07.1998 Автори: Кузьмін В. О., Гапонюк О. М., Іжелюк І. В. Виданий: Український інститут промислової власності”, м. Київ, Україна вул. Глазунова, 1 – 1998. – 1с.
71. 1. Корольков П.М. Особенности термической обработки сварных соединений трубопроводов из коррозионностойкой стали.- Сварочное производство. – 2005. – № 7. – С. 48–52.
72. Спосіб виробництва литих сталевих корпусів бурового інструменту  
Лавров А.И., Ловырев П.Б., Бабкин В.А. и др. Теплогенератор. Свидетельство на полезную модель № 29130. – БИ. – 2003
73. «Спосіб виробництва литих сталевих корпусів бурового інструменту»  
Номер патенту: 27377 Оpubліковано: 25.10.2007 Автори: Галініч В. І., Богаченко О. Г. Виданий Український інститут

- промислової власності”, м. Київ, МСП, 03680, Україна вул. Глазунова, 1 – 2011. – 4 с.
74. «Спосіб вакуумної термічної обробки сталевих виробів» Номер патенту: 96557 Опубліковано: 10.11.2011 Автори: Шурінов Р. В., Бадіян Є. Ю., Шеховцов О. В., Тонкопряд А. Г. Виданий: ДП “Український інститут промислової власності”, м. Київ, МСП, 03680, Україна вул. Глазунова, 1 – 2011. – 6 с.
75. Новиков М.П. Основы технологии складання машин і механізмів. - М.: Машинобудування, 1980. – 592 с.
76. Анкирский Б. М. Влияние вибрационной и термической обработки на механические свойства металла и сварного соединения стали 20 К // Сварочное производство. – 1985. – № 3. – С. 19–21.
77. Сагалевич В. М., Аверин А. С. Методы стабилизации размеров сварных конструкций из низкоуглеродистой стали послесварочной вибрационной обработкой. — М.: МВТУ им. Баумана. Деп. НИИмаш, 1982. – № 19. – 14 с.
78. Мрыка Е. Устранение остаточных напряжений с помощью нагружения и вибрации // Сб. науч. статей: Современные проблемы сварки и специальной электрометаллургии. – К.: Наукова думка, 1980. – С. 65–84.
79. Сутырин Г. В. Снижение остаточных напряжений сварных соединений низкочастотной вибрационной обработкой // Сварочное производство. – 1983. – № 2. – С. 22–24.
80. Янус Ю. Р. Исследование влияния вибрационного воздействия на релаксацию остаточных напряжений, структуру и свойства конструкционных сталей и алюминиевых сплавов // Автореферат диссерт. на соиск. ученой степени. – С. 1988. – 21 с.
81. ДСТУ 2865-94 Контроль неруйнівний. Терміни та визначення.
82. ГОСТ 20415-82 Контроль неразрушающий. Методы акустические. Общие положения.
83. Грузд А. А. Исследование деформации сварных конструкций во времени и изыскание способов их учета и стабилизации. – К.: 1973. – 193 с.
84. Махненко В. И., Пивторак Н. И. Перераспределение остановочных напряжений в сварных балках при вибрационной обработке // Автоматическая сварка. – 1978. – № 9. – С. 28–31.
85. Применение метода вибростабилизации при изготовлении сварных



- деталей металлорежущих станков / В. И. Алилуев, Г. П. Демьяненко, Г. И. Лащенко и др. // Технология производства, научная организация труда и управления. – 1977. – № 11. – С. 5–9.
- 86.8Лащенко Г. И. Вибрационная обработка сварных конструкций. — К.: Сварщик. – 2000. – № 5. – С. 6–7.
- 87.Лащенко Г. И. Структура технологических процессов изготовления сварных конструкций // Автоматическая сварка. – 1996. – № 4. – С. 32–35.
- 88.Грузд А. А. Исследование деформации сварных конструкций во времени и изыскание способов их учета и стабилизации. – К.: 1973. – 193 с.
- 89.Махненко В. И., Пивторак Н. И. Перераспределение остановочных напряжений в сварных балках при вибрационной обработке // Автоматическая сварка. – 1978. – № 9. – С. 28–31.
- 90.Применение метода вибростабилизации при изготовлении сварных деталей металлорежущих станков / В. И. Алилуев, Г. П. Демьяненко, Г. И. Лащенко и др. // Технология производства, научная организация труда и управления. – 1977. – № 11. – С. 5–9.
- 91.Сагалевиц В. М. Методы устранения сварочных деформаций и напряжений. – М.: Машиностроение, 1974. – 248 с.
- 92.Лащенко Г. И. Технологические особенности дуговой сварки в углекислом газе с вибронгружением // Свариваемость и технология сварки конструкционных сталей и чугунов. – К.: ИЭС им. Е. О. Патона. – 1985. – С. 98–104.
- 93.Влияние вибраций низкой частоты на величину остаточных напряжений и деформаций при сварке /Г. В. Сутырин, Н. Э. Банцерж, В. С. Белосельский и др. // Сварочное производство. – 1973. – № 6. – С. 31–32.
- 94.Сутырин Г. В. Технологические основы повышения качества металла при наложении на электрическую дугу и изделие низкочастотных вибраций. – Т.: Тульский политехнический институт, 1984. – 35 с.
- 95.Сутырин Г. В. Влияние вибраций низкой частоты на технологическую прочность сварных соединений // Механизация и автоматизация сварочного производства. – Т.: ТПИ. – 1977. – С. 97–99.
- 96.Ощепков Ю. П., Кузнецов В. В., Ощепкова Н. В. Выбор оптимальных режимов вибрации при индукционном нанесении

- покрытий из хромоникелевых сплавов // Сварочное производство. – 1979. – № 8. – С. 17–18.
97. Гозман Я. Б. Вибрационная обработка деталей для стабилизации их размеров // Станки и инструментарий. – 1985. – № 4. – С. 29–31.
98. Писаренко В. С., Вержбинская И. И. Снижение остаточных напряжений вибрационной обработкой // Обзорная информация. – М.: НИИИНФОРМТЯЖМАШ, 1972. – 38 с.
99. Сагалевиц В. М., Аверин А. С. Выбор режимов для вибрационной обработки сварных конструкций из низкоуглеродистой стали с целью стабилизации их размеров. – М.: 1982. – 12 с. – Деп. НИИмаш, 153–82.
100. Ковалев А.В. Ключев В.В. Соснин Ф.Р. Неразрушающий контроль и диагностика: Справочник (под ред. Ключева В.В.. – Изд. 3-е, перераб., доп. – Машиностроение, 2005. – 656 с.
101. Васильков Д.В., Васильков С.Д., Иванов С.Ю. Новые подходы к оценке остаточного ресурса изделий по напряжённому состоянию неразрушающим методом АФЧХ-гестирования. Физика, химия и механика грибосистем: Межвуз.сб.науч.тр. / под ред. В.Н.Латышева. – Иваново: Иван.гос.ун-т, 2006. – Вып.5. – С. 23–25.
102. Венфинович В.И. Принципы и практика диагностики напряженно-деформированного состояния конструкций, изделий и сварных соединений // В мире неразрушающего контроля. – С Пб, 1(27) март. – 2005. – С. 4–9.
103. 2. Tyurin Yu. N. Electric heating using a liquid electrode / Y. N. Tyurin, A. D. Pogrebnyak // Surface and Coatings Technology. - 2001. – P. 293–299.
104. 3. Hohmann M. Production methods and applications for high-quality metal powders and sprayformed products / M. Hohmann, G. Brooks, C. Spiegelhauer Produktionsmethoden und Anwendungen fur qualitativ hochwertige Metallpulver und spruhkompaktierte Halbzeuge. Stahl und Eisen. – 2005.-258p.
105. 4. Yasa E. Application of laser re-melting on Selective laser melting parts. Catholic University of Leuven, Dept. of Mech. Eng, Heverlee, Belgium. Advances in Production Engineering / E. Yasa, J. Kruth Management 6.-2011.- 259-270 p.
106. 5. David, L. A Brief History of Additive / L .David Bourella, J. Joseph Beaman, Jr.a, Ming C. Leub and W. David Rosenc.-Manufacturing and

- the 2009 Roadmap for Additive Manufacturing: Looking Back and Looking Ahead. RapidTech.-2009.-328p.
107. Dutta B. et. al. Additive Manufacturing by Direct Metal Deposition Advanced Materials & Processed • MAY.-2011.-33-36 p.
108. Fngelo, H. C. Powder Metalurge: Science, technology and application. H. C. Fngelo, R. Subramanian– New Dehli,-2009.-128p.
109. Kruglov I.A. Neural networks modeling of multivariable vector functions in ill-posed approximation problems / I.A. Kruglov, O.A. Mishulina // Journal of Computer and System Sciences International, 2013. – Vol. 52. No. 4. – Pp. 503-518.
110. Ковалевский С. В. Акустический контроль размеров и показателей шероховатости поверхностей деталей с применением нейросетевых моделей / С. В. Ковалевский, Е. С. Ковалевская, А. И. Нагиева // Нейросітьові технології та їх застосування : збірник праць міжнародної наукової конференції. – Краматорськ : ДДМА, 2014. С. 24-35
111. Ковалевский С. В. Развитие методов акустической диагностики в машиностроении: монографія / С. В. Ковалевский, Е. С. Ковалевская, В. И. Тулупов. – Краматорск : ДГМА, 2014. – 91 с.
112. Математические основы обработки сигналов. Практикум: учебное пособие / О.С. Вадутов; Томский политехнический университет. – 3-е изд., испр. и доп. – Томск: Изд-во Томского политехнического университета, 2014. – 102 с.
113. Акустическая диагностика статических и динамических свойств механизмов с параллельной кинематикой // Комплексне забезпечення якості технологічних процесів та систем (КЗЯТПС – 2017): матеріали тез доповідей VII міжнародної науково-практичної конференції (м. Чернігів, 24–27 квіт. 2017 р.) : у 2-х т. / Чернігівський національний технологічний університет [та ін.]; відп. за вип.: Єрошенко Андрій Михайлович [та ін.]. – Чернігів : ЧНТУ, 2017. – Т. 1. – С. 59-60.
114. Осипов Л. А. Обработка сигналов на цифровых процессорах. Линейно-аппроксимирующий метод / Осипов Л. А. — М. : Горячая линия — Телеком, 2001. — 114 с.
115. Селиванов С.Г., Гузаиров М.Б. Системотехника инновационной подготовки производства в машиностроении. – М.: Машиностроение, 2012. – 568 с.

116. Смирнов, В.А. Кинетостатическое моделирование энергоэффективного управления оборудованием с параллельной кинематикой / В.А Смирнов // Вестник ЮУрГУ. Серия «Машиностроение». - 2010. - Вып. 16. - № 29. - С. 65-71
117. Христофоров А.В. Методы анализа спектра сигнала. Учебно-методическое пособие к специальному лабораторному практикуму для студентов старших курсов и магистрантов кафедр радиофизического направления. Казань 2004, 21 с.
118. Жук А.Я., Малышев Г.П., Желябина Н.К., Клевцов О.М. Техническая диагностика. Контроль и прогнозирование: монография // Запорожье: Издательство Запорожской государственной инженерной академии, 2008. – 500 с.

Scientific publication

KOVALEVSKY Serhiy Volodymyrovych  
KOVALEVSKA Olena Serhiivna

MAGNETIC RESONANCE  
MATERIAL PROCESSING

Monograph

Edited by the author

Computer typesetting by I.I. Dyakov

17/2020. Format 60 x 84/16. Mind. printing. arch. 6.51.  
Obl.-vid. arch. 3.45. Circulation 300 copies. Deputy №.

Donbass State Machine-Building Academy  
84313, Kramatorsk, street Academic, 72.  
Certificate of submission of the subject of publishing  
to the State Register  
series DK № 1633 dated 24.12.2003.